



LEISTUNGSERKLÄRUNG



Nr. 0008 – DE

1. Eindeutiger Kenncode des Produkttyps: **fischer FIS GREEN**

2. Verwendungszweck(e):

Produkt	Verwendungszweck (e)
Injektionsdübel aus Metall zur Verwendung im Mauerwerk	Zur Befestigung und/oder Verankerung von Tragwerksteilen (die zur Standsicherheit des Bauwerks beitragen) oder schweren Elementen

3. Hersteller: **fischerwerke GmbH & Co. KG, Otto-Hahn-Straße 15, 79211 Denzlingen, Deutschland**

4. Bevollmächtigter: --

5. System(e) zur Bewertung und Überprüfung der Leistungsbeständigkeit: **1**

6a. Harmonisierte Norm: ---

Notifizierte Stelle(n): ---

6b. Europäisches Bewertungsdokument: **ETAG 029; 2013-04**

Europäische Technische Bewertung: **ETA-14/0471; 2015-02-03**

Technische Bewertungsstelle: **DIBt**

Notifizierte Stelle(n): **1343 – MPA Darmstadt**

7. Erklärte Leistung(en):

**Mechanische Festigkeit und Standsicherheit (BWR 1)**

Wesentliches Merkmal	Leistung
Charakteristische Werte für Zug- und Querbeanspruchung	Siehe Anhang, insbesondere Anhänge C 1 bis C 3
Charakteristische Biegemomente	Siehe Anhang, insbesondere Anhang C 4
Verschiebungen unter Zug- und Querbeanspruchung	Siehe Anhang, insbesondere Anhang C 4
Reduktionsfaktor für Baustellenversuche ( $\beta$ -Faktor)	Siehe Anhang, insbesondere Anhang C 4
Rand- und Achsabstände	Siehe Anhang, insbesondere Anhang C 5

**Brandschutz (BWR 2)**

Wesentliches Merkmal	Leistung
Brandverhalten	Der Dübel erfüllt die Anforderungen der Klasse A1
Feuerwiderstand	Keine Leistung festgestellt (KLF)

8. Angemessene Technische Dokumentation und/oder Spezifische Technische Dokumentation: ---

Die Leistung des vorstehenden Produkts entspricht der erklärten Leistung/den erklärten Leistungen. Für die Erstellung der Leistungserklärung im Einklang mit der Verordnung (EU) Nr. 305/2011 ist allein der obengenannte Hersteller verantwortlich.

Unterzeichnet für den Hersteller und im Namen des Herstellers von:

Andreas Bucher, Dipl.-Ing.

Wolfgang Hengesbach, Dipl.-Ing., Dipl.-Wirtsch.-Ing.

Tumlingen, 2015-02-05

- Diese Leistungserklärung wurde in verschiedenen Sprachversionen erstellt. Für den Fall unterschiedlicher Auslegung hat immer die englische Version Vorrang.
- Der Anhang enthält freiwillige und ergänzende Informationen in englischer Sprache. Diese gehen über die (sprachneutral angegebenen) gesetzlichen Anforderungen hinaus.

**Specific Part**

**1 Technical description of the product**

The fischer injectionsystem FIS GREEN for masonry is a bonded anchor (injection type) consisting of a mortar cartridge with fischer injection mortar, a perforated sieve sleeve and an anchor rod with hexagon nut and washer or an internal threaded rod in the range of M6 to M16. The steel elements are made of zinc coated steel, stainless steel or high corrosion resistant steel.

The anchor rod is placed into a drilled hole filled with injection mortar and is anchored via the bond between steel element, injection mortar and masonry and mechanical interlock.

The product description is given in Annex A.

**2 Specification of the intended use in accordance with the applicable European Assessment Document**

The performances given in Section 3 are only valid if the anchor is used in compliance with the specifications and conditions given in Annex B.

The verifications and assessment methods on which this European Technical Assessment is based lead to the assumption of a working life of the anchor of at least 50 years. The indications given on the working life cannot be interpreted as a guarantee given by the producer, but are to be regarded only as a means for choosing the right products in relation to the expected economically reasonable working life of the works.

**3 Performance of the product and references to the methods used for its assessment**

**3.1 Mechanical resistance and stability (BWR 1)**

Essential characteristic	Performance
Characteristic resistance for tension and shear loads	See Annex C 1 – C 3
Characteristic resistance for bending moments	See Annex C 4
Displacements under shear and tension loads	See Annex C 4
Reduction Factor for job site tests ( $\beta$ -Factor)	See Annex C 4
Edge distances and spacing	See Annex C 5

**3.2 Safety in case of fire (BWR 2)**

Essential characteristic	Performance
Reaction to fire	Anchorage satisfy requirements for Class A1
Resistance to fire	No performance determined (NPD)

**3.3 Hygiene, health and the environment (BWR 3)**

Regarding dangerous substances there may be requirements (e.g. transposed European legislation and national laws, regulations and administrative provisions) applicable to the products falling within the scope of this European Technical Assessment. In order to meet the provisions of Regulation (EU) No 305/2011, these requirements need also to be complied with, when and where they apply.

**3.4 Safety in use (BWR 4)**

The essential characteristics regarding Safety in use are included under the Basic Works Requirement Mechanical resistance and stability.

**3.5 Protection against noise (BWR 5)**

Not applicable.

**3.6 Energy economy and heat retention (BWR 6)**

Not applicable.

**3.7 Sustainable use of natural resources (BWR 7)**

The sustainable use of natural resources was not investigated.

**3.8 General aspects**

The verification of durability is part of testing the essential characteristics. Durability is only ensured if the specifications of intended use according to Annex B are taken into account.

**4 Assessment and verification of constancy of performance (AVCP) system applied, with reference to its legal base**

According to Decision of the Commission of 17 February 1997 (97/177/EC) (OJ L 073 of 14.03.97 p. 24-25), the system of assessment and verification of constancy of performance (see Annex V and Article 65 Paragraph 2 to Regulation (EU) No 305/2011) given in the following table applies.

Product	Intended use	Level or class	System
Metal injection anchors for use in masonry	For fixing and/or supporting to masonry, structural elements (which contributes to the stability of the works) or heavy units	—	1

**Installed conditions part 1**

**Threaded rods with perforated sleeve FIS H K; Installation in perforated and solid brick masonry**

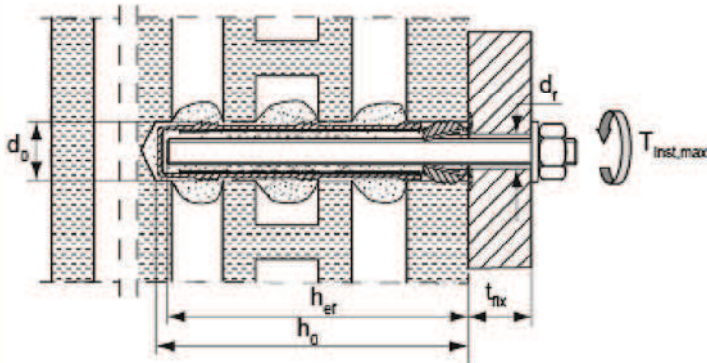

**Pre-positioned installation**

- FIS H 12x85 K
- FIS H 16x85 K
- FIS H 16x130 K
- FIS H 20x85 K
- FIS H 20x130 K
- FIS H 20x200 K

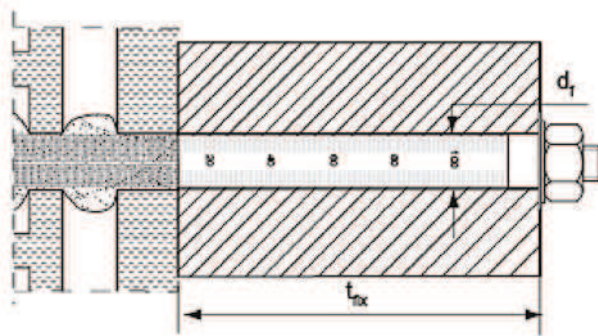

**Push-through installation**

- FIS H 18x130/200 K
- FIS H 22x130/200 K

**Internal threaded anchors FIS E with perforated sleeve FIS H K; Installation in perforated and solid brick masonry**

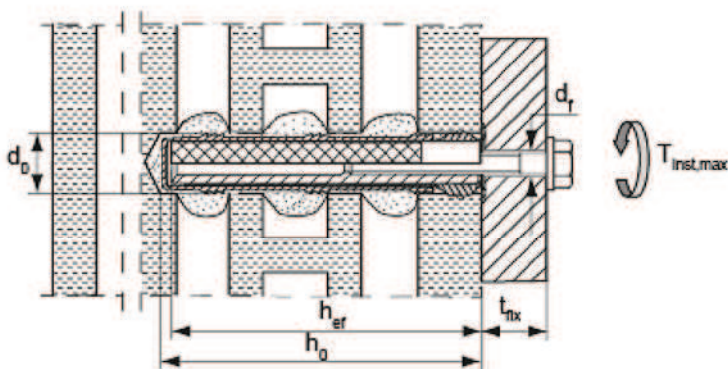

**Pre-positioned installation**

- FIS H 16x85 K – FIS E 11x85
- FIS H 20x85 K – FIS E 15x85

$h_{ef}$  = effective anchorage depth  
 $h_0$  = depth of drill hole  
 $t_{fix}$  = thickness of fixture

$d_0$  = nominal drill bit diameter  
 $d_f$  = diameter of clearance hole in the fixture  
 $T_{inst,max}$  = maximum torque moment

**fischer Injectionsystem FIS GREEN for masonry**

**Product description**  
Installed condition, part 1

**Annex A 1**

**Installed conditions part 2**

**Threaded rods without perforated sleeve FIS H K; Installation in solid brick masonry and aerated concrete**

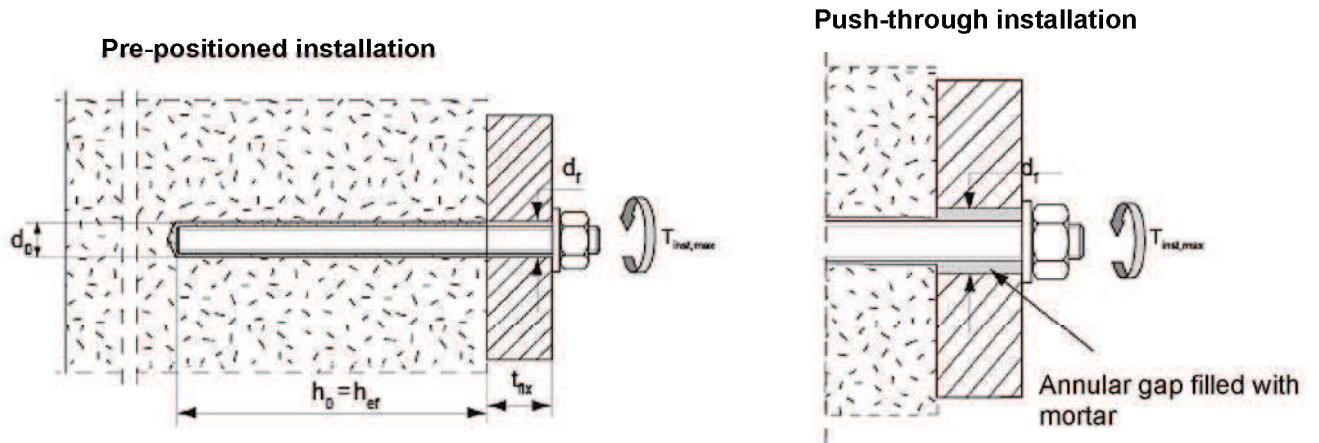

**Internal threaded anchors FIS E without perforated sleeve FIS H K; Installation in solid brick masonry and aerated concrete**

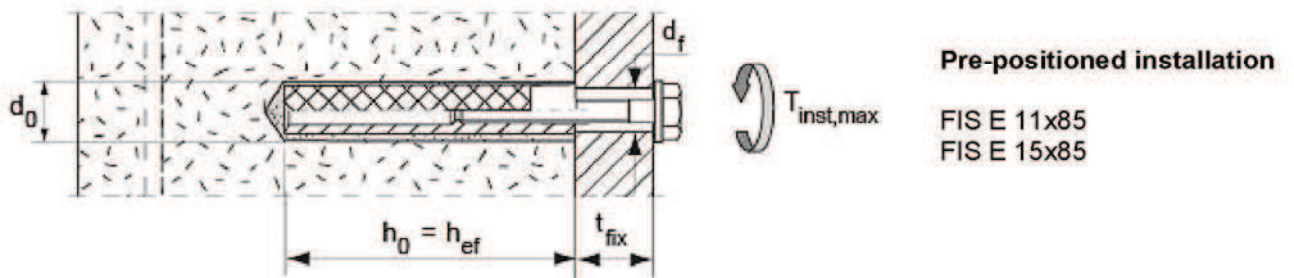

$h_{ef}$  = effective anchorage depth  
 $h_0$  = depth of drill hole  
 $t_{fix}$  = thickness of fixture

$d_0$  = nominal drill bit diameter  
 $d_f$  = diameter of clearance hole in the fixture  
 $T_{inst,max}$  = maximum torque moment

**fischer Injectionsystem FIS GREEN for masonry**

**Product description**  
 Installed condition, part 2

**Annex A 2**

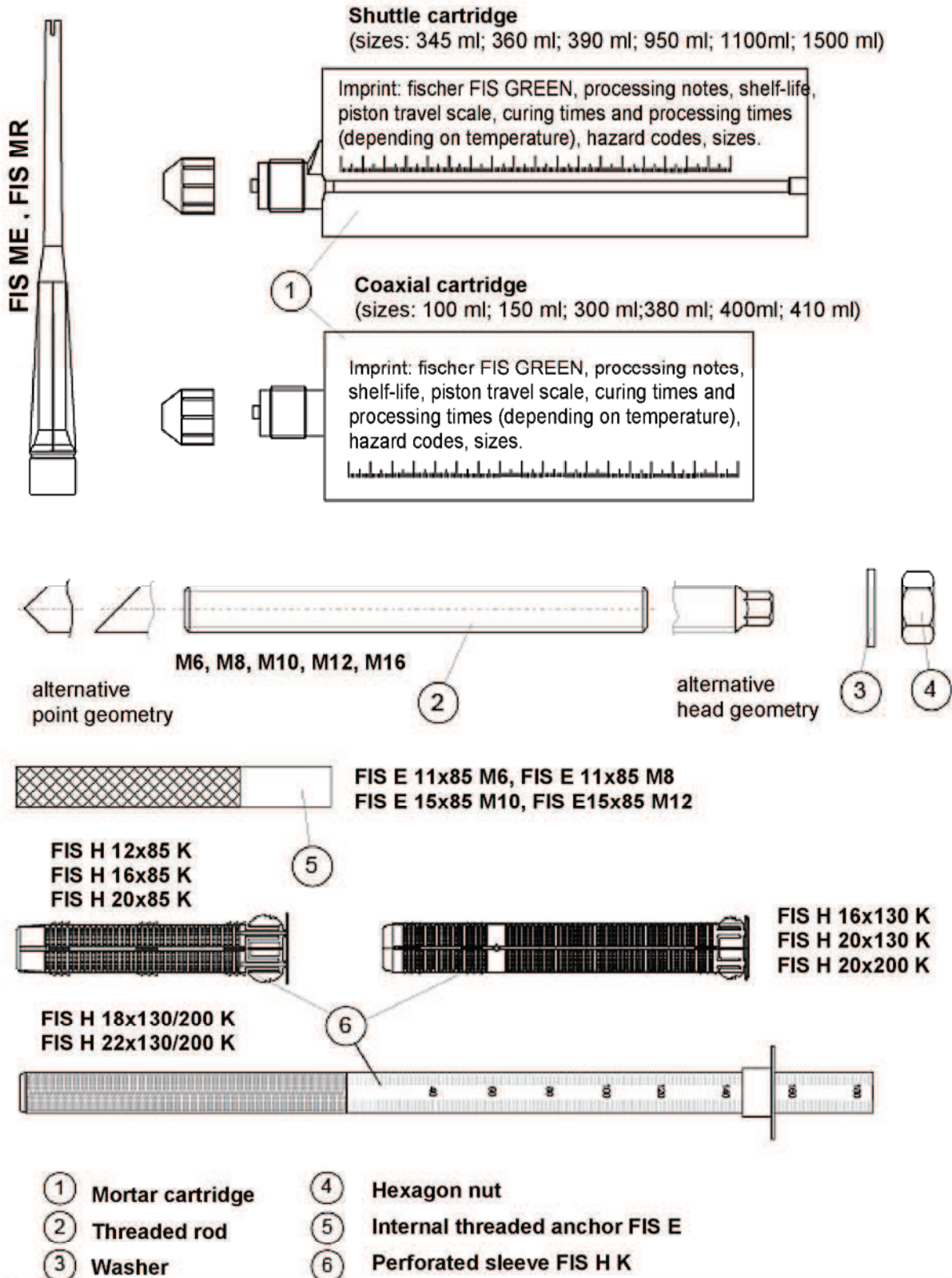

fischer Injectionsystem FIS GREEN for masonry

**Product description**  
Cartridges, anchor rods, internal threaded anchors, perforated sleeves

**Annex A 3**

**Table A1: Materials**

<b>Part</b>	<b>Designation</b>	<b>Material</b>		
1	Mortar cartridge	Bio based mortar, hardener; fillers		
		Steel, zinc plated	Stainless steel A4	High corrosion-resistant steel c
2	Threaded rod	Property class 5.8 or 8.8; ISO 898-1:2013 zinc plated $\geq 5\mu\text{m}$ , EN ISO 4042 A2K or hot-dip galvanised EN ISO 10684:2004 $f_{uk} \leq 1000 \text{ N/mm}^2$ $A_5 > 8\%$	Property class 50, 70 or 80 EN ISO 3506:2009 1.4401; 1.4404; 1.4578; 1.4571; 1.4439; 1.4362; 1.4062 EN 10088-1:2014 $f_{uk} \leq 1000 \text{ N/mm}^2$ $A_5 > 8\%$	Property class 50 or 80 EN ISO 3506:2009 or property class 70 with $f_{yk} = 560 \text{ N/mm}^2$ 1.4565; 1.4529 EN 10088-1:2014 $f_{uk} \leq 1000 \text{ N/mm}^2$ $A_5 > 8\%$
3	Washer ISO 7089:2000	zinc plated $\geq 5\mu\text{m}$ , EN ISO 4042:1999 A2K or hot-dip galvanised ISO 10684:2004	1.4401; 1.4404; 1.4578; 1.4571; 1.4439; 1.4362 EN 10088-1:2014	1.4565; 1.4529 EN 10088-1:2014
4	Hexagon nut	Property class 5 or 8; ISO 898-2:2013 zinc plated $\geq 5\mu\text{m}$ , ISO 4042:1999 A2K or hot-dip galvanised ISO 10684:2004	Property class 50, 70 or 80 ISO 3506:2009 1.4401; 1.4404; 1.4578; 1.4571; 1.4571; 1.4439; 1.4362 EN 10088-1:2014	Property class 50, 70 or 80 ISO 3506:2009 1.4565; 1.4529 EN 10088-1:2014
5	Internal threaded anchor FIS E	Property class 5.8; ISO 898-1:2013 zinc plated $\geq 5\mu\text{m}$ , EN ISO 4042:1999 A2K	Property class 70 EN ISO 3506:2009 1.4401; 1.4404; 1.4578; 1.4571; 1.4439; 1.4362 EN 10088-1:2014	Property class 70 EN ISO 3506-1:2009 1.4565; 1.4529 EN 10088-1:2014
6	Perforated sleeve FIS H K	PP / PE		

fischer Injectionsystem FIS GREEN for masonry

Product description  
Materials**Annex A 4**

**Specifications of intended use**

**Anchorage subject to:**

- Static and quasi-static loads

**Base materials:**

- Solid brick masonry (Use category b) and autoclaved aerated masonry (Use category d), acc. to Annex B 7.  
Note: The characteristic resistance is also valid for larger brick sizes and higher compressive strength of the masonry unit.
- Hollow brick masonry (use category c), according to Annex B 7.
- Mortar strength class of the masonry M2,5 at minimum according to EN 998-2:2010.
- For other bricks in solid masonry and in hollow or perforated masonry, the characteristic resistance of the anchor may be determined by job site tests according to ETAG 029, Annex B under consideration of the  $\beta$ -factor according to Annex C 4, Table C4.

**Temperature Range:**

- From - 40°C to +80°C (max. short term temperature +80°C and max. long term temperature +50°C)

**Use conditions (Environmental conditions):**

- Dry and wet structure (regarding injection mortar).
- Structures subject to dry internal conditions (zinc coated steel, stainless steel or high corrosion resistant steel).
- Structures subject to external atmospheric exposure including industrial and marine environment (stainless steel or high corrosion resistant steel).
- Structures subject to permanently damp internal condition, if no particular aggressive conditions exist (stainless steel or high corrosion resistant steel).
- Structures subject to external atmospheric exposure and to permanently damp internal condition, if other particular aggressive conditions (high corrosion resistant steel)  
Note: Particular aggressive conditions are e.g. permanent, alternating immersion in seawater or the splash zone of seawater, chloride atmosphere of indoor swimming pools or atmosphere with extreme chemical pollution (e.g. in desulphurization plants or road tunnels where de-icing materials are used).

**Design:**

- The anchorages have to be designed in accordance with the ETAG 029, Annex C, Design method A under the responsibility of an engineer experienced in anchorages and masonry work.
- Verifiable calculation notes and drawings have to be prepared taking account the relevant masonry in the region of the anchorage, the loads to be transmitted and their transmission to the supports of the structure. The position of the anchor is indicated on the design drawings.

**Installation:**

- Dry or wet structures (use category d/d and use category w/w).
- Hole drilling by hammer drill mode.
- In case of aborted hole: The hole shall be filled with mortar
- Anchor installation carried out by appropriately qualified personnel and under the supervision of the person responsible for technical matters of the site.
- Fastening screws or threaded rods (including nut and washer) must comply with the appropriate material and property class of the fischer internal threaded anchor FIS E
- min. curing time see table B3
- Commercial standard threaded rods, washers and hexagon nuts may also be used if the following requirements are fulfilled:  
material dimensions and mechanical properties of the metal parts according to the specifications are given in Annex A4, Table A1  
conformation of material and mechanical properties of the metal parts by inspection certificate 3.1 according to EN 10204:2004, the documents shall be stored.  
marking of the threaded rod with the envisage embedment depth. This may be done by the manufacturer of the rod or by a person on job site.

**fischer Injectionsystem FIS GREEN for masonry**

**Intended Use Specifications**

**Annex B 1**



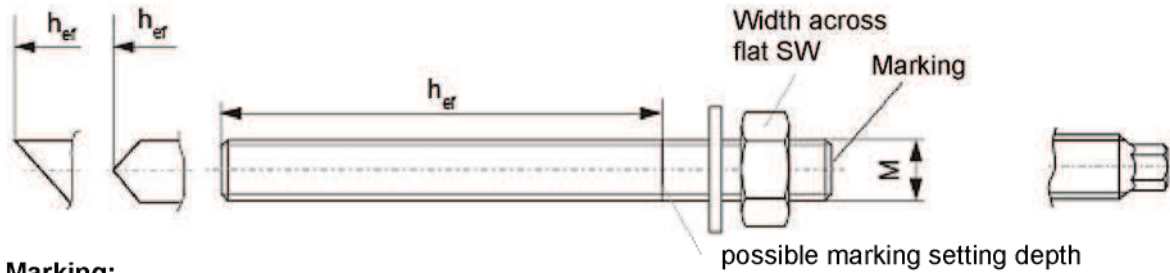

**Marking:**

Property class 8.8 or high corrosion-resistant steel C, property class 80: •

Stainless steel A4, property class 50 and high corrosion-resistant steel C, property class 50: ••

**Table B1.1: Installation parameters (threaded rod without perforated sleeve)**

Size			M6	M8	M10	M12	M16
Nominal drill hole diameter	$d_{nom}=d_0$	[mm]	8	10	12	14	18
Width across flat	SW	[mm]	10	13	17	19	24
Effective anchorage depth <sup>1)</sup>	$h_{ef,min}$	[mm]	50				100
Depth of drill hole $h_0 = h_{ef}$	$h_{ef,max}$	[mm]	200				
Maximum torque moment	$T_{inst,max}$	[Nm]	4	10			
Max. torque moment for aerated concrete	$T_{inst,max}$	[Nm]	1	2	4		
Diameter of clearance hole in the fixture	Pre-position anchorage	$d_f \leq$	7	9	12	14	18
	Push through anchorage	$d_f \leq$	9	11	14	16	20

<sup>1)</sup>  $h_{ef,min} \leq h_{ef} \leq h_{ef,max}$  is possible.

**fischer internal threaded anchor FIS E**

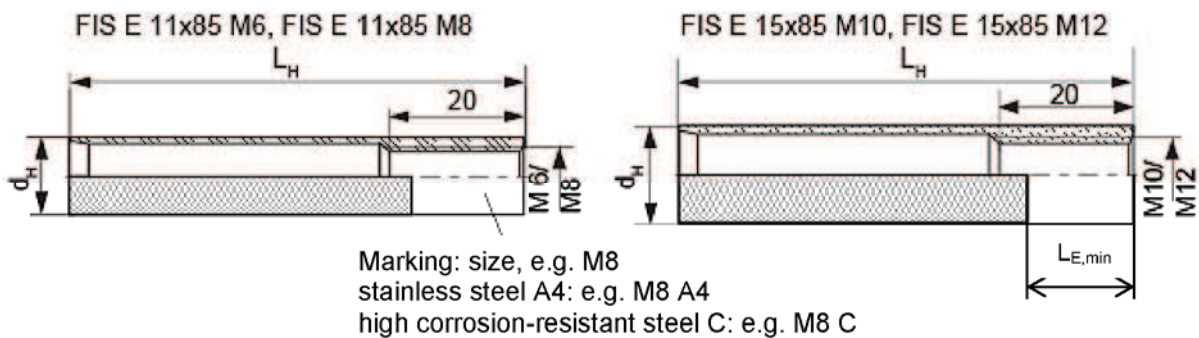

**Table B1.2: Installation parameters (internal threaded anchor FIS E without perforated sleeve)**

Size FIS E			11x85 M6	11x85 M8	15x85 M10	15x85 M12
Nominal drill hole diameter	$d_{nom}=d_0$	[mm]	14		18	
Depth of drill hole	$h_0$	[mm]	90			
Effective anchorage depth	$L_H=h_{ef}$	[mm]	85			
Maximum torque moment	$T_{inst,max}$	[mm]	4	10		
Max. torque moment for aerated concrete	$T_{inst,max}$	[mm]	4			
Diameter of clearance hole in the fixture	$d_f \leq$	[mm]	7	9	12	14
Screw-in depth	$L_{E,min}$	[mm]	6	8	10	12

fischer Injectionsystem FIS GREEN for masonry

Intended Use  
 Installation parameters, part 1

Annex B 2

**Perforated sleeves FIS H 12x85; 16x85; 16x130; 20x85; 20x130; 20x200 K**

Marking: size  
 $D_{\text{Sleeve}} \times L_{\text{Sleeve}}$   
 e.g. 16x85

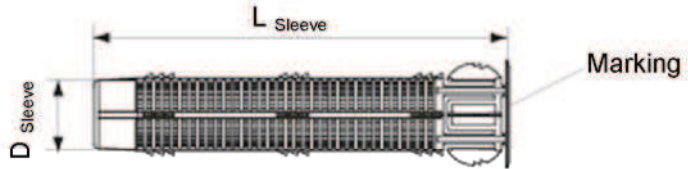
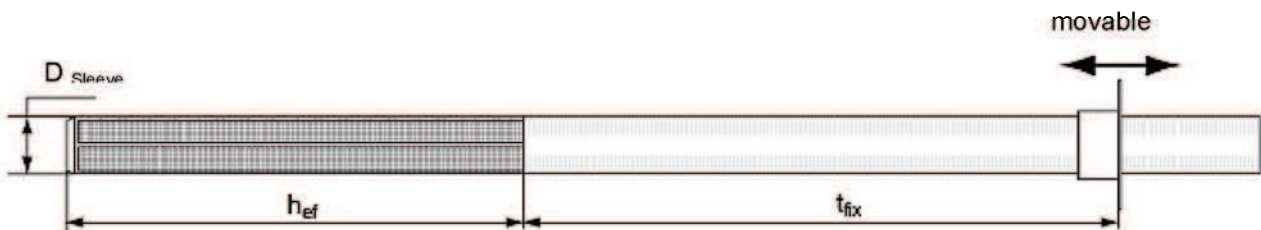

**Table B1.3: Installation parameters (threaded rod and internal threaded anchor with perforated sleeve; only pre-positioned anchorage)**

Size FIS H...K			12x85	16x85	16x130	20x85	20x130	20x200
Nominal drill hole diameter ( $d_0 = D_{\text{Sleeve}}$ )	$d_{\text{nom}}=d_0$	[mm]	12	16		20		
Depth of drill hole	$h_0$	[mm]	90	90	135	90	135	205
Effective anchorage depth <sup>1)</sup>	$h_{\text{ef,min}}$	[mm]	85	85	110	85	110	180
	$h_{\text{ef,max}}$	[mm]	85	85	130	85	130	200
Size of threaded rod		[-]	M6, M8	M8, M10		M12, M16	M12, M16	
Size of internal threaded anchor		[-]	----	11x85	----	15x85	----	----
Maximum torque moment threaded rod and internal threaded anchor	$T_{\text{inst,max}}$	[mm]	2	4				

<sup>1)</sup>  $h_{\text{ef,min}} \leq h_{\text{ef}} \leq h_{\text{ef,max}}$  is possible.

**Perforated sleeves FIS H 18x130/200 K and FIS H 22x130/200 K**



**Table B1.4: Installation parameters (threaded rod with perforated sleeve; push-through anchorage)**

Size FIS H...K			18x130/200	22x130/200
Nominal drill hole diameter ( $d_0 = D_{\text{Sleeve}}$ )	$d_{\text{nom}}=d_0$	[mm]	18	22
Depth of drill hole	$h_0$	[mm]	$135 + t_{\text{fix}}$	
Effective anchorage depth	$h_{\text{ef,min}}$	[mm]	130	
Size of threaded rod		[-]	M10 or M12	M16
Maximum torque moment threaded rod	$T_{\text{inst,max}}$	[Nm]	4	
Diameter of clearance hole in the fixture	$d_f \leq$	[mm]	18	22
Thickness of fixture	$t_{\text{fix,max}}$	[mm]	200	

fischer Injectionsystem FIS GREEN for masonry

Intended Use  
 Installation parameters, part 2.

**Annex B 3**

**Steel brush BS**



Only for solid bricks and aerated concrete

**Table B2: Parameters of steel brush**

Drill hole diameter	$d_0$	[mm]	8	10	12	14	16	18	20	22
Brush diameter	$d_{b, nom}$	[mm]	9	11	14	16	20	20	25	25

**Table B3: Maximum processing time of the mortar and minimum curing time**

(During the curing time of the mortar the masonry temperature may not fall below the listed minimum temperature).

Temperature at anchoring base [°C]	Minimum curing time <sup>1)</sup> $t_{cure}$ [minutes]	System-temperature (mortar) [°C]	Maximum processing time $t_{work}$ [minutes]
>±0 to +5	6 hours	+5	13
>+5 to +10	4 hours	+10	9
>+10 to +20	90	+20	5
>+20 to +30	60	+30	4
>+30 to +40	30	+40	2

<sup>1)</sup> For wet masonry the curing time must be doubled.

**fischer Injectionsystem FIS GREEN for masonry**





**Intended Use**

Steel brush  
Processing times and curing times





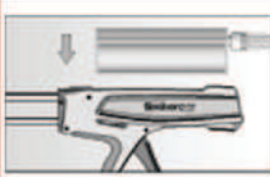

**Annex B 4**

## Installation instructions

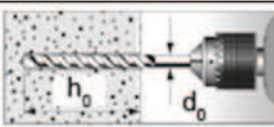
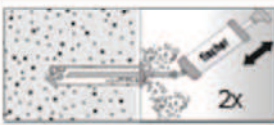
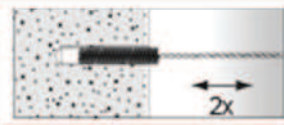
### Preparing the cartridge

1		Remove the sealing cap.		Screw on the static mixer (the spiral in the static mixer must be clearly visible).
2		Place the cartridge into the dispenser.		Press approx. 10 cm of material out until the resin is well mixed. Mortar which is not grey in colour will not cure and must be disposed off.

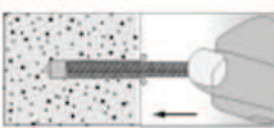
### Installation in solid brick and aerated concrete (without perforated sleeve)

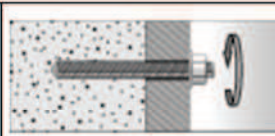
3		Drill the hole. Depth of drill hole $h_0$ and drill hole diameter $d_0$ see Table B1.1 or B1.2		
4				Blow out the drill hole twice. Brush twice and blow out twice again.
5		Fill approx. 2/3 of the drill hole with mortar beginning from the bottom of the hole <sup>1)</sup> . Avoid bubbles.		For push through installation (not FIS E) fill the annular gap also with mortar.
6		Only use clean and oil-free elements. Mark the threaded rod for setting depth. Insert the threaded rod or internal threaded anchor FIS E by hand using light turning motions. When reaching the setting depth mark, excess mortar must exit the drill hole.		
7		Do not touch. Minimum curing time see Table B3		Mounting the fixture. $T_{inst,max}$ see Table B1.1 or B1.2

<sup>1)</sup> For the exact quantity of mortar see manufacturer's specification.

**Installation in perforated or solid brick with perforated sleeve (pre-positioned anchorage)**

3		Drill the hole (hammer drill). Depth of drill hole $h_0$ and drill hole diameter $d_0$ see Table B1.3	When installing the perforated sleeve in solid bricks or solid areas of hollow bricks, also clean the hole by blowing and brushing.
4		Insert the perforated sleeve flush with the surface of the masonry or plaster.	Fill the perforated sleeve completely with mortar beginning from the bottom of the hole. <sup>1)</sup>
5		Insert the anchor rod or internal threaded anchor FIS E by hand using light turning motions till reaching the setting depth mark (= length of perforated sleeve)	
6		Do not touch. Minimum curing time see Table B3	Tighten the hexagon nut. $T_{inst,max}$ see Table B1.3

<sup>1)</sup> For the exact quantity of mortar see manufacturer's specification.

**Installation in perforated or solid brick with perforated sleeve (push-through anchorage)**

3		Push the movable stop up to the correct thickness of fixture and cut the overlap	Drill the hole through the fixture. Depth of drill hole ( $h_0+t_{fix}$ ) and drill hole diameter see Table B1.4
4		Insert the perforated sleeve flush with the surface of the fixture.	Fill the sleeve with mortar beginning from the bottom of the drill hole. <sup>1)</sup> For deep drill holes use an extension tube.
5		Insert the anchor rod by hand using light turning motions till reaching the setting depth mark (= length of perforated sleeve).	
6		Do not touch. Minimum curing time see Table B3	Tighten the hexagon nut. $T_{inst,max}$ see Table B1.4

<sup>1)</sup> For the exact quantity of mortar see manufacturer's specification.

fischer Injectionsystem FIS GREEN for masonry

Intended Use  
Installation instructions part 2

Annex B 6

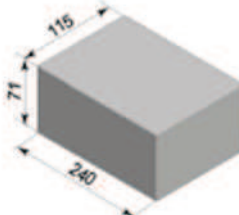
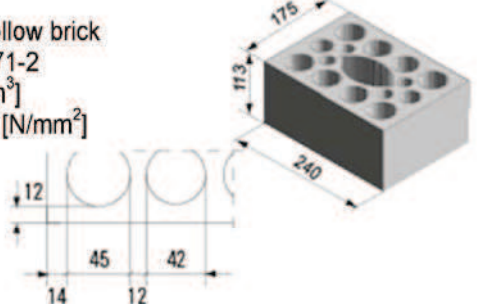
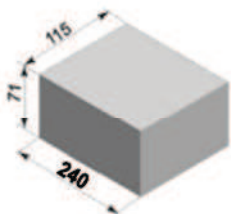
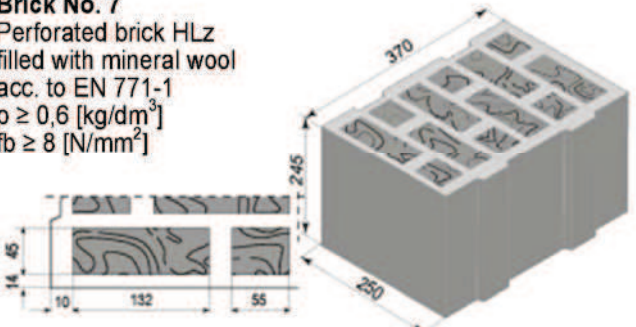
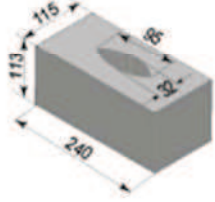
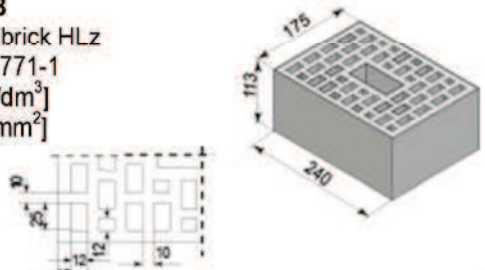
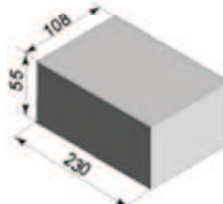
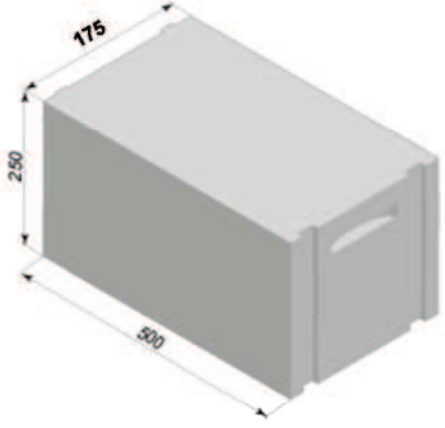
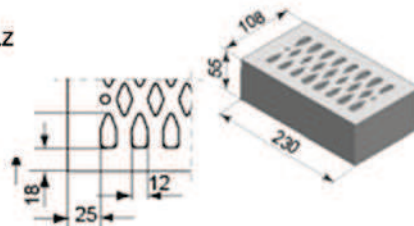









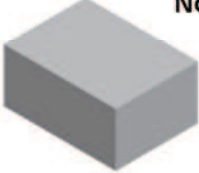





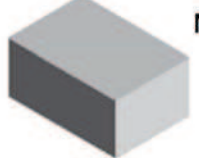

<p><b>Brick No. 1</b> Solid brick Mz acc. to EN 771-2 <math>\rho \geq 1,8</math> [kg/dm<sup>3</sup>] <math>fb \geq 10</math> or 20 [N/mm<sup>2</sup>]</p> 	<p><b>Brick No. 6</b> Sand-lime hollow brick acc. to EN 771-2 <math>\rho \geq 1,4</math> [kg/dm<sup>3</sup>] <math>fb \geq 12</math> or 20 [N/mm<sup>2</sup>]</p> 
<p><b>Brick No. 2</b> Solid sand-lime brick acc. to EN 771-2 <math>\rho \geq 1,8</math> [kg/dm<sup>3</sup>] <math>fb \geq 10</math> or 20 [N/mm<sup>2</sup>]</p> 	<p><b>Brick No. 7</b> Perforated brick HLz filled with mineral wool acc. to EN 771-1 <math>\rho \geq 0,6</math> [kg/dm<sup>3</sup>] <math>fb \geq 8</math> [N/mm<sup>2</sup>]</p> 
<p><b>Brick No. 3</b> Solid sand-lime brick acc. to EN 771-2 <math>\rho \geq 1,8</math> [kg/dm<sup>3</sup>] <math>fb \geq 10</math> or 20 [N/mm<sup>2</sup>]</p> 	<p><b>Brick No. 8</b> Perforated brick HLz acc. to EN 771-1 <math>\rho \geq 0,9</math> [kg/dm<sup>3</sup>] <math>fb \geq 10</math> [N/mm<sup>2</sup>]</p> 
<p><b>Brick No. 4</b> Solid brick Mz acc. to EN 771-2 <math>\rho \geq 1,8</math> [kg/dm<sup>3</sup>] <math>fb \geq 20</math> [N/mm<sup>2</sup>]</p> 	<p><b>Brick No. 9</b> Aerated concrete block <math>\rho \geq 350</math> or 500 or 650 [kg/dm<sup>3</sup>] <math>fb \geq 2</math> or 4 or 6 [N/mm<sup>2</sup>]</p> 
<p><b>Brick No. 5</b> Perforated brick HLz acc. to EN 771-1 <math>\rho \geq 1,4</math> [kg/dm<sup>3</sup>] <math>fb \geq 8</math> [N/mm<sup>2</sup>]</p> 	

fischer Injectionsystem FIS GREEN for masonry

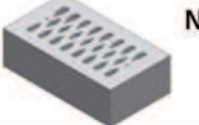
**Intended Use**  
Types and dimensions of blocks and bricks

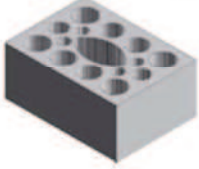
**Annex B 7**

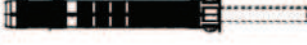
**Table B4.1: Allocation of anchor rods<sup>1)</sup>, perforated sleeves<sup>1)</sup> and bricks**

Bricks	Valid anchor rods and perforated sleeves
 <p><b>No.1</b></p>	 M6; M8; M10; M12  FIS E 11x85 FIS E 15x85
 <p><b>No.2</b></p>	 M6; M8; M10; M12  FIS E 11x85 FIS E 15x85
 <p><b>No.3</b></p>	 FIS H 12x85 K; FIS H 16x85 K;  FIS H 20x85 K; FIS H 16x130K; FIS H 20x130 K  FIS H 18x130/200K, FIS H 22x130/200K
 <p><b>No.4</b></p>	 M6; M8; M10; M12  FIS E 11x85 FIS E 15x85
 <p><b>No.5</b></p>	 FIS H 12x85 K; FIS H 16x85 K; FIS H 20x85 K
 <p><b>No.6</b></p>	 FIS H 12x85 K; FIS H 16x85 K;  FIS H 20x85 K; FIS H 16x130K; FIS H 20x130 K  FIS H 18x130/200K, FIS H 22x130/200K



<sup>1)</sup> Other combinations can be used after job site tests acc. to ETAG 029, Annex B. The  $\beta$ - factor for this job site tests are given in Table C4

**fischer Injectionsystem FIS GREEN for masonry**

**Annex B 8**

**Intended Use**  
Allocation of anchor rods, perforated sleeves and bricks, part 1

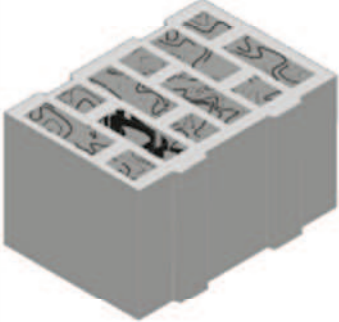
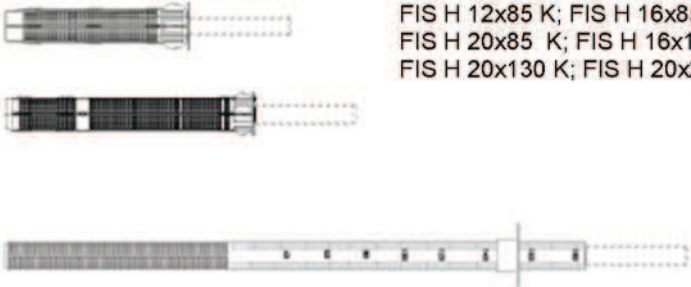
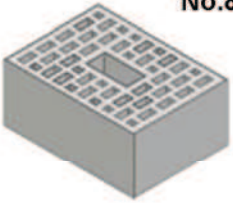
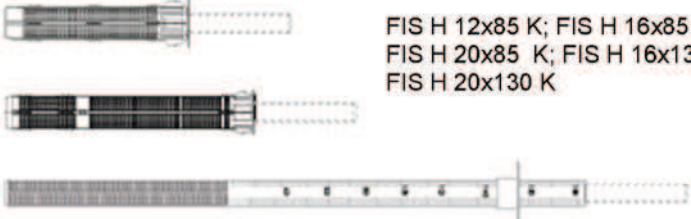
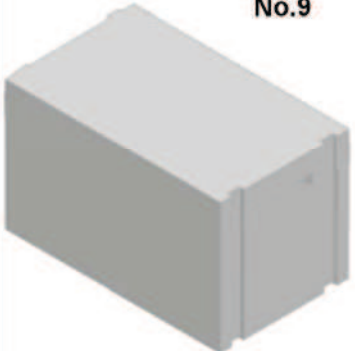
**Table B4.2: Allocation of anchor rods<sup>1)</sup>, perforated sleeves<sup>1)</sup> and bricks**

Bricks	Valid anchor rods and perforated sleeves
<p style="text-align: right;"><b>No.7</b></p> 	 <p style="text-align: right;">FIS H 12x85 K; FIS H 16x85 K; FIS H 20x85 K; FIS H 16x130K; FIS H 20x130 K; FIS H 20x200 K</p> <p style="text-align: right;">FIS H 18x130/200K, FIS H 22x130/200K</p>
<p style="text-align: right;"><b>No.8</b></p> 	 <p style="text-align: right;">FIS H 12x85 K; FIS H 16x85 K; FIS H 20x85 K; FIS H 16x130K; FIS H 20x130 K</p> <p style="text-align: right;">FIS H 18x130/200K, FIS H 22x130/200K</p>
<p style="text-align: right;"><b>No.9</b></p> 	 <p style="text-align: right;">M6;M8; M10; M12; M16</p> <p style="text-align: right;">FIS E 11x85; FIS E 15x85</p>

<sup>1)</sup> Other combinations can be used after job site tests acc. to ETAG 029, Annex B.  
The  $\beta$ - factor for this job site tests are given in Table C4

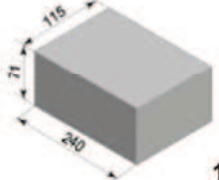
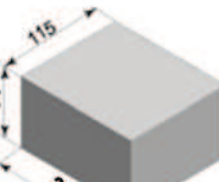
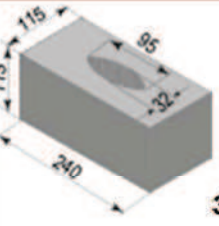
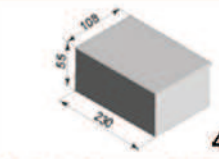

**Table C1.1: Characteristic values of resistance to tension loads and to shear loads for solid bricks**

Brick No.	Density $\rho$ [kg/dm <sup>3</sup> ] - Compressive strength $f_b$ [N/mm <sup>2</sup> ]	Sleeve FIS H...K	Anchor size or screw size in internal threaded anchor	Effective anchorage depth		Characteristic resistance [kN]				All categories
				$h_{ef,min}$ [mm]	$h_{ef,max}$ [mm]	$N_{RK}^{1)}$		$V_{RK}^{2)}$		
						Temp. 24/40°C		Temp. 50/80°C		
				d/d	w/w	d/d	w/w			
 <p>1</p>	$\rho \geq 1,8$ $f_b \geq 20$ ( $f_b \geq 10$ )	without	M6	50	85	1,5 (1,5)	0,9 (0,9)	1,5 (1,5)	0,9 (0,9)	4,0 (2,5)
			M8	50	200	2,5 (2,5)	2,5 (2,5)	2,5 (2,5)	2,5 (2,5)	
			M10	50	79	4,5 (3,0)		4,5 (3,0)		6,0 (4,0)
			M10	80	199	6,0 (4,5)		6,0 (4,5)		
			M10	200	200	12,0 (11,0)		12,0 (11,0)		12,0 (8,5)
			M12	50	79	4,0 (3,0)		4,0 (3,0)		5,5 (4,0)
			M12	80	199	7,0(5,0)		7,0 (5,0)		
			M12	200	200	10,0 (7,0)		10,0 (7,0)		12,0 (11,5)
FIS E M6/8, FIS E M10/M12	85	85	6,0 (4,5)		6,0 (4,5)		4,0 (2,5)			
 <p>2</p>	$\rho \geq 1,8$ $f_b \geq 20$ ( $f_b \geq 10$ )	without	M6	50	85	1,5 (1,5)	0,9 (0,9)	1,5 (1,5)	0,9 (0,9)	4,0 (3,0)
			M8	50	200	2,5 (2,5)		2,5 (2,5)		5,5 (4,0)
			M10	50	79	3,0 (2,0)		3,0 (2,5)		
			M10	80	199	4,0 (3,0)		4,0 (3,0)		
			M10	200	200	12,0 (9,0)		12,0 (9,0)		7,0 (5,0)
			M12	50	79	3,0 (2,0)		3,0 (2,0)		
			M12	80	199	4,5 (3,0)		4,5 (3,0)		
			M12	200	200	12,0 (9,0)		12,0 (9,0)		4,0 (3,0)
FIS E M6/8, FIS E M10/M12	85	85	4,0 (2,5)		4,0 (2,5)					
 <p>3</p>	$\rho \geq 1,8$ $f_b \geq 20$ ( $f_b \geq 10$ )	12x85	M6/8	85	85	8,0 (5,5)		4,5 (3,0)		5,5 (3,5)
		16x85	M8/M10	85	85	4,5 (3,5)		3,0 (2,0)		
		20x85	M12/M16	85	85	12,0 (9,5)		8,0 (5,5)		
		16x130 18x130/200	M8/M10 M10/M12	110	130	4,5 (3,0)		2,5 (2,0)		
		20x130 22x130/200	M12/M16 M16	110	130	8,5 (6,0)		5,0 (3,5)		
 <p>4</p>	$\rho \geq 1,8$ $f_b \geq 20$	without	M6	50	200	1,5	0,9	1,5	0,9	2,5
			M8	50	200	2,0		2,0		4,0
			M10	50	200	2,0		2,0		5,5
			M12	50	200	3,0		3,0		

<sup>1)</sup> For design according to ETAG 029, Annex C:  $N_{RK} = N_{RK,d} = N_{RK,b} = N_{RK,s}$

<sup>2)</sup> For design according to ETAG 029, Annex C:  $V_{RK} = V_{RK,d} = V_{RK,c} = V_{RK,s}$

fischer Injectionsystem FIS GREEN for masonry

**Performances**  
Characteristic values of resistance to tension load and shear load, part 1

**Annex C 1**

**Table C1.2: Characteristic values of resistance to tension loads and to shear loads for perforated bricks**

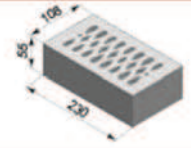
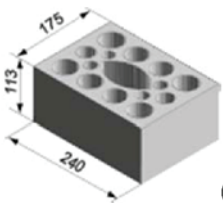
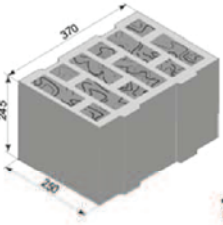
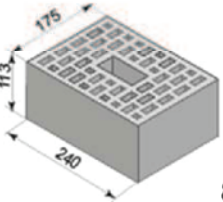
Brick No.	Density $\rho$ [kg/dm <sup>3</sup> ] - Compressive strength $f_b$ [N/mm <sup>2</sup> ]	Sleeve FIS H...K	Anchor size or screw size in internal threaded anchor	Effective anchorage depth		Characteristic resistance [kN]				
				$n_{ef,min}$ [mm]	$n_{ef,max}$ [mm]	$N_{Rk}$ <sup>1)</sup>				$V_{Rk}$ <sup>2)</sup>
						Temp. 24/40°C		Temp. 50/80°C		
						d/d	w/w	d/d	w/w	All categories
 <b>5</b>	$\rho \geq 1,4$ $f_b \geq 8$	12x85 16x85 20x85	M6/M8 M8/M10 M12/M16	85	85	3,5	2,0	2,5		
 <b>6</b>	$\rho \geq 1,4$ $f_b \geq 20$ ( $f_b \geq 12$ )	12x85	M6/M8	85	85	3,5 (2,0)	2,0 (1,2)	4,5 (2,5)		
		16x85	M8/M10	85	85			8,0 (5,5)		
		20x85	M10, M12/M16,	85	85	5,5 (3,5)	3,5 (2,0)	7,5 (4,5)		
		16x130 18x130/200	M8/M10 M10/M12	110	130			8,0 (5,5)		
		20x130 22x130/200	M12/M16 M16	110	130	4,5 (2,5)	2,5 (1,5)	7,5 (4,5)		
 <b>7</b>	$\rho \geq 0,6$ $f_b \geq 8$	12x85	M6/M8	85	85	2	1,2	2,5		
		16x85	M8/M10	85	85	1,5	0,9	3,0		
		20x85	M12, M16	85	85	2,0	1,2	1,5		
		16x130 18x130/200	M8/M10 M10/M12	130	130	2,5	1,5	3,0		
		20x130 22x130/200	M12/M16 M16	110	130	2,0	1,2	1,5		
		20x200	M12/M16	180	200	2,5	1,5	1,5		
 <b>8</b>	$\rho \geq 0,9$ $f_b \geq 10$	12x85	M6, M8	85	85	3,5	2,0	4,0		
		16x85	M8, M10	85	85	3,5	2,0	5,5		
		20x85	M12, M16	85	85	4,0	2,5	6,0		
		16x130 18x130/200	M8/M10 M10/M12	110	130	4,5	2,5	5,5		
		20x130 22x130/200	M12/M16 M16	110	130	3,5	2,0	6,0		

<sup>1)</sup> For design according to ETAG 029, Annex C:  $N_{Rk} = N_{Rk,p} = N_{Rk,b} = N_{Rk,s}$

<sup>2)</sup> For design according to ETAG 029, Annex C:  $V_{Rk} = V_{Rk,b} = V_{Rk,c} = V_{Rk,s}$

fischer Injectionsystem FIS GREEN for masonry

**Performances**  
Characteristic values of resistance to tension load and shear load, part 2

**Annex C 2**

**Table C1.3: Characteristic values of resistance to tension loads and shear loads for aerated concrete**

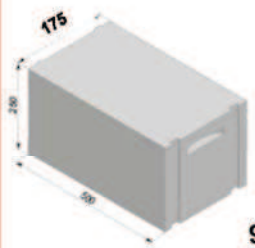
Brick No.	Density $\rho$ [kg/dm <sup>3</sup> ] - Compressive strength $f_b$ [N/mm <sup>2</sup> ]	Sleeve FIS H...K	Anchor size or screw size in internal threaded anchor	Effective anchorage depth		Characteristic resistance [kN]				
				$h_{ef,min}$ [mm]	$h_{ef,max}$ [mm]	$N_{Rk}$ <sup>1)</sup>				$V_{Rk}$ <sup>2)</sup>
						Temp. 24/40°C		Temp. 50/80°C		All categories
						d/d	w/w	d/d	w/w	
	$\rho \geq 350$ $f_b \geq 2$	without	M6	100	200	1,5	1,2	1,5	1,2	0,9
			M8	100	200	2,0	1,5	2,0	1,5	
			M10	100	200	2,0	1,5	2,0	1,5	
			M12	100	200	2,5	2,0	2,5	2,0	
			M16	100	200	2,5	2,0	2,5	2,0	1,2
	$\rho \geq 500$ $f_b \geq 4$	without	M6	100	200	2,0	1,5	2,0	1,5	1,5
			M8	100	200	2,5	2,0	2,5	2,0	
			M10	100	200	3,0	2,0	3,0	2,0	
			M12	100	200	3,0	2,5	3,0	2,5	
			M16	100	200	3,0	2,5	3,0	2,5	
	$\rho \geq 650$ $f_b \geq 6$	without	M6	100	200	2,5	2,0	2,5	2,0	2,5
			M8	100	200	3,5	2,5	3,5	2,5	
			M10	100	200	4,0	3,0	4,0	3,0	
			M12	100	200	4,0	3,0	4,0	3,0	
			M16	100	200	4,0	3,0	4,0	3,0	2,0

<sup>1)</sup> For design according to ETAG 029, Annex C:  $N_{Rk} = N_{Rk,p} = N_{Rk,b} = N_{Rk,s}$

<sup>2)</sup> For design according to ETAG 029, Annex C:  $V_{Rk} = V_{Rk,b} = V_{Rk,c} = V_{Rk,s}$

fischer Injectionsystem FIS GREEN for masonry

**Performances**

Characteristic values of resistance to tension loads and shear loads for aerated concrete, part 3

**Annex C 3**

**Table C2: Characteristic bending moments**

Size					M6	M8	M10	M12	M16
Characteristic bending moment $M_{Rk,s}$	Zinc-plated steel	Property class	5.8	[Nm]	8	19	37	65	166
			8.8	[Nm]	12	30	60	105	266
	Stainless steel A4	Property class	50	[Nm]	8	19	37	65	166
			70	[Nm]	11	26	52	92	232
	High corrosion-resistant steel C	Property class	50	[Nm]	8	19	37	65	166
			70 <sup>1)</sup>	[Nm]	11	26	52	92	232
			80	[Nm]	12	30	60	105	266

<sup>1)</sup>  $f_{uk} = 700 \text{ N/mm}^2$ ;  $f_{yk} = 560 \text{ N/mm}^2$

**Table C3: Displacements under tension load and shear load**

	N [kN]	$\delta_{N0}$	$\delta_{N\infty}$	V [kN]	$\delta_{V0}$	$\delta_{V\infty}$
		[mm]	[mm]		[mm]	[mm]
Solid bricks <sup>1)</sup>	$\frac{N_{Rk}}{1,4 * \gamma_M}$	1,32	2,64	$\frac{V_{Rk}}{1,4 * \gamma_M}$	1,2	1,8
Perforated bricks <sup>2)</sup>		1,0	2,0		1,9	2,85
Aerated concrete		1,0	2,0		2,93	4,4

<sup>1)</sup> Brick No.: 1; 2; 3; 4

<sup>2)</sup> Brick No.: 5; 6; 7; 8

**Table C4:  $\beta$ - factor for job site tests according to ETAG 029, Annex B**

Brick No.	Size	$\beta$ - Factor			
		Temp 24°C/40°C		Temp 50°C/80°C	
		d/d	w/w	d/d	w/w
1	M6;M8	0,8	0,48	0,80	0,48
	M12x200	0,78	0,78	0,78	0,78
	Other sizes	0,84	0,84	0,84	0,84
2	Other sizes	0,84	0,84	0,81	0,81
	M8x200	0,55	0,55	0,55	0,54
	M6x50	0,84	0,51	0,84	0,51
3	All sizes	0,84	0,84	0,51	0,5
4	Other sizes	0,84	0,84	0,84	0,84
	M6x50	0,84	0,51	0,84	0,51
5	All sizes	0,71	0,71	0,43	0,43
6	All sizes	0,84	0,84	0,51	0,50
7	Other sizes	0,84	0,84	0,51	0,51
	20x130,20x200	0,67	0,67	0,41	0,4
8	All sizes	0,84	0,84	0,51	0,50
9	All sizes	1,0	0,79	1,0	0,79

fischer Injectionsystem FIS GREEN for masonry

#### Performances

Characteristic bending moments; displacements;  $\beta$ - factors for job site tests

**Annex C 4**

**Table C5: Edge distance and spacing (installation with and without sleeves)**

Direction to bed joint		⊥					Min. thickness of the masonry members [mm]
Brick No.	h <sub>ef</sub> [mm]	C <sub>min</sub>	S <sub>min</sub>	S <sub>cr</sub>	S <sub>min</sub>	S <sub>cr</sub>	
		[mm]	[mm]	[mm]	[mm]	[mm]	
1, 2	50	100	150	150			h <sub>ef</sub> + 30 (≥ 80)
	80	100	240	240			
	200	150	300	300			
3	85	100	255	255			
	130	100	390	390			
4	50	100	150	150			
5	all sizes	100	55	230			
6	all sizes	100	115	240			
7	all sizes	120	240	250			
8	all sizes	120	115	240			
9	all sizes	80	115	240			

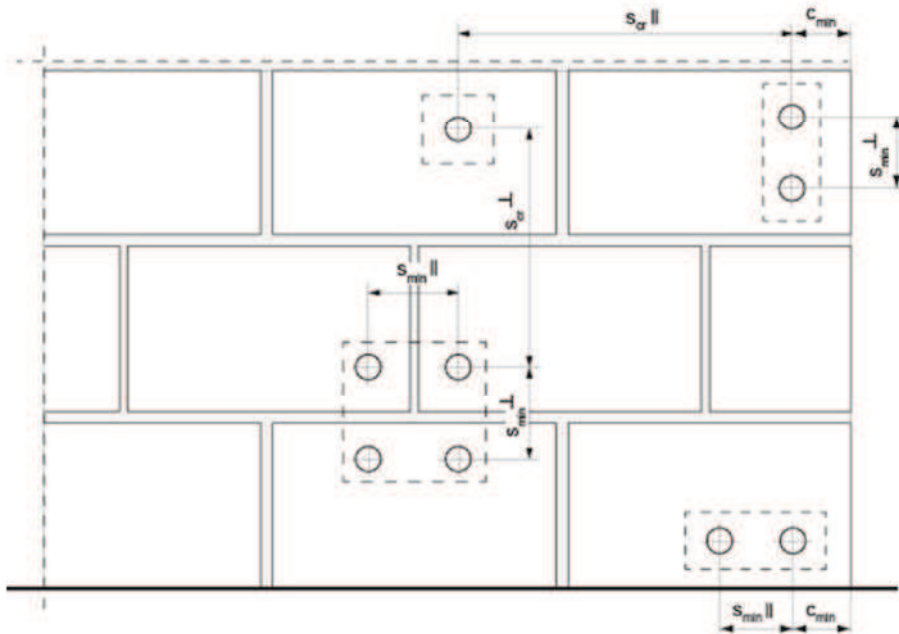

**s<sub>min</sub> ||** = Minimum spacing anchor group parallel to bed joint  
**s<sub>min</sub> ⊥** = Minimum spacing anchor group vertical to bed joint  
**s<sub>cr</sub> ||** = Characteristic spacing anchor group parallel to bed joint  
**s<sub>cr</sub> ⊥** = Characteristic spacing anchor group vertical to bed joint  
**c<sub>cr</sub> = c<sub>min</sub>** = Edge distance  
**group of 2 anchors:** N<sub>Rk</sub><sup>g</sup>=2x N<sub>Rk</sub> ; V<sub>Rk</sub><sup>g</sup>=2x V<sub>Rk</sub>  
**group of 4 anchors:** N<sub>Rk</sub><sup>g</sup>=4x N<sub>Rk</sub> ; V<sub>Rk</sub><sup>g</sup>=4x V<sub>Rk</sub>

fischer Injectionsystem FIS GREEN for masonry

Performances  
Edge distance and spacing

Annex C 5