



**LEISTUNGSERKLÄRUNG**

Nr. 0074 – DE

1. Eindeutiger Kenncode des Produkttyps: **Bewehrungsanschluss mit fischer FIS VL**

2. Verwendungszweck(e):

Produkt	Verwendungszweck (e)
Mörtel für Bewehrungsanschlüsse	Nachträglicher Anschluss von Betonstahl durch Verankerung oder Übergreifungsstoß in Normalbeton, siehe Anhang, insbesondere Anhänge B 1 bis B 9

3. Hersteller: **fischerwerke GmbH & Co. KG, Klaus-Fischer-Straße 1, 72178 Waldachtal, Deutschland**

4. Bevollmächtigter: --

5. System(e) zur Bewertung und Überprüfung der Leistungsbeständigkeit: **1**

6a. Harmonisierte Norm: ---

Notifizierte Stelle(n): ---

6b. Europäisches Bewertungsdokument: **ETAG 001; 2013-04**

Europäische Technische Bewertung: **ETA-15/0539; 2015-08-27**

Technische Bewertungsstelle: **DIBt**

Notifizierte Stelle(n): **1343 – MPA Darmstadt**

7. Erklärte Leistung(en):

**Mechanische Festigkeit und Standsicherheit (BWR 1)**

Wesentliches Merkmal	Leistung
Bemessungswerte des Widerstandes gegen Verbundversagen	Siehe Anhang, insbesondere Anhang C 1

Wesentliches Merkmal	Leistung
Brandverhalten	Der Bewehrungsanschluss erfüllt die Anforderungen der Klasse A 1
Feuerwiderstand	Leistung nicht bewertet

8. Angemessene Technische Dokumentation und/oder Spezifische Technische Dokumentation: ---

Die Leistung des vorstehenden Produkts entspricht der erklärten Leistung/den erklärten Leistungen. Für die Erstellung der Leistungserklärung im Einklang mit der Verordnung (EU) Nr. 305/2011 ist allein der obengenannte Hersteller verantwortlich.

Unterzeichnet für den Hersteller und im Namen des Herstellers von:

Andreas Bucher, Dipl.-Ing.

Wolfgang Hengesbach, Dipl.-Ing., Dipl.-Wirtsch.-Ing.

*i.V. A. Bucher*

*i.V. W. Hengesbach*

Tumlingen, 2015-09-25

- Diese Leistungserklärung wurde in verschiedenen Sprachversionen erstellt. Für den Fall unterschiedlicher Auslegung hat immer die englische Version Vorrang.
- Der Anhang enthält freiwillige und ergänzende Informationen in englischer Sprache. Diese gehen über die (sprachneutral angegebenen) gesetzlichen Anforderungen hinaus.

**Specific Part**

**1 Technical description of the product**

The subject of this approval is the post-installed connection, by anchoring or overlap connection joint, of reinforcing bars (rebars) in existing structures made of normal weight concrete, using the injection mortar fischer FIS VL in accordance with the regulations for reinforced concrete construction.

Reinforcing bars made of steel with a diameter  $\phi$  from 10 to 25 mm and injection mortar FIS VL are used for rebar connections. The steel element is placed into a drilled hole filled with injection mortar and is anchored via the bond between embedded element, injection mortar and concrete.

The product description is given in Annex A.

**2 Specification of the intended use in accordance with the applicable European Assessment Document**

The performances given in Section 3 are only valid if the rebar connection is used in compliance with the specifications and conditions given in Annex B.

The verifications and assessment methods on which this European Technical Assessment is based lead to the assumption of a working life of the anchor of at least 50 years. The indications given on the working life cannot be interpreted as a guarantee given by the producer, but are to be regarded only as a means for choosing the right products in relation to the expected economically reasonable working life of the works.

**3 Performance of the product and references to the methods used for its assessment**

**3.1 Mechanical resistance and stability (BWR 1)**

Essential characteristic	Performance
Design values of the ultimate bond resistance	See Annex C 1

**3.2 Safety in case of fire (BWR 2)**

Essential characteristic	Performance
Reaction to fire	Rebar connections satisfy requirements for Class A1
Resistance to fire	No performance assessed

**3.3 Hygiene, health and the environment (BWR 3)**

Regarding dangerous substances there may be requirements (e.g. transposed European legislation and national laws, regulations and administrative provisions) applicable to the products falling within the scope of this European Technical Assessment. In order to meet the provisions of Regulation (EU) No 305/2011, these requirements need also to be complied with, when and where they apply.

**3.4 Safety in use (BWR 4)**

The essential characteristics regarding Safety in use are included under the Basic Works Requirement Mechanical resistance and stability.

**4 Assessment and verification of constancy of performance (AVCP) system applied, with reference to its legal base**

In accordance with guideline for European technical approval ETAG 001, April 2013 used as European Assessment Document (EAD) according to Article 66 Paragraph 3 of Regulation (EU) No 305/2011 the applicable European legal act is: [96/582/EC].

The system to be applied is: 1

**Installation anchor**

**Figure A1:**  
Overlap joint with existing reinforcement for rebar connections of slabs and beams

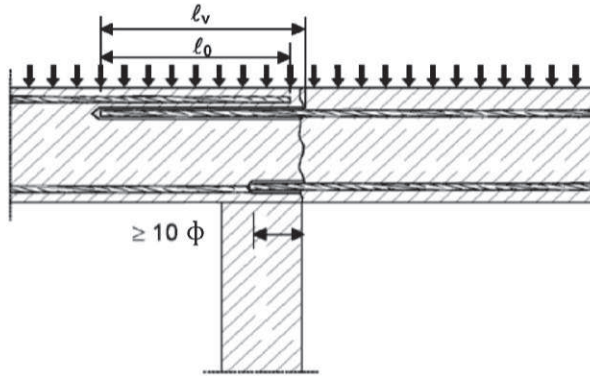

**Figure A2:**  
Overlap joint with existing reinforcement at a foundation of a column or wall where the rebars are stressed

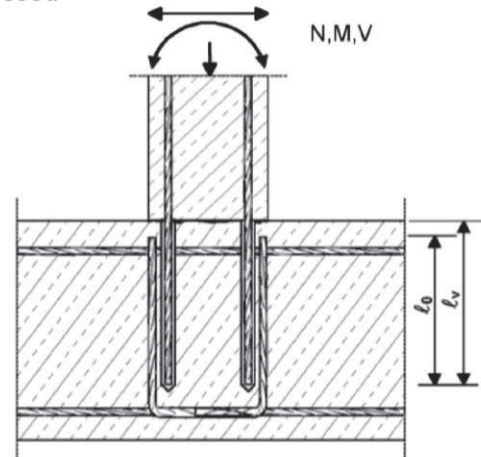

**Figure A3:**  
End anchoring of slabs of beams (e.g. designed as simply supported)

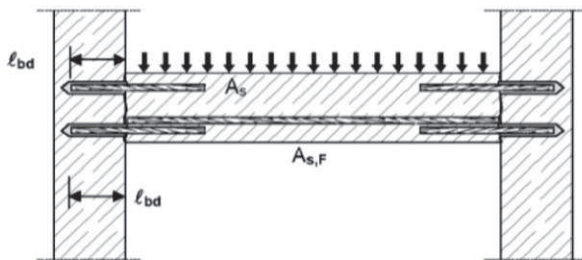

**Figure A4:**  
Rebar connection for stressed primarily in compression

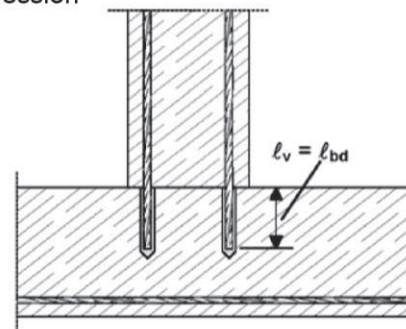

**Figure A5:**  
Anchoring of reinforcement to cover the enveloped line of acting tensile force in the bending member

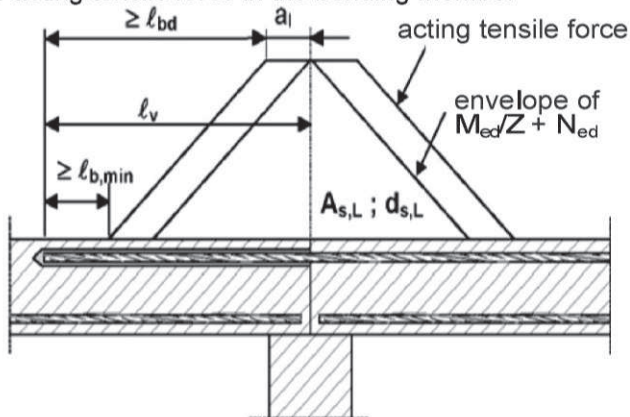

Note to **Figure A1 to A5**

In the Figures no traverse reinforcement is plotted, the traverse reinforcement shall comply with EN 1992-1-1:2004+AC:2010.

Preparing of joints according to **Annex B 2**

**Rebar connection with fischer FIS VL**

**Annex A 1**

**Product description**

Installed condition and examples of use for rebars

**Injection cartridge fischer FIS VL**

Shuttle cartridge, sizes: 345 ml, 360 ml; 390 ml, 950 ml, 1500 ml

Marking: FIS VL, processing notes, shelf-life, hazard code, curing times and processing times (depending on temperature), piston travel scale, size, volume

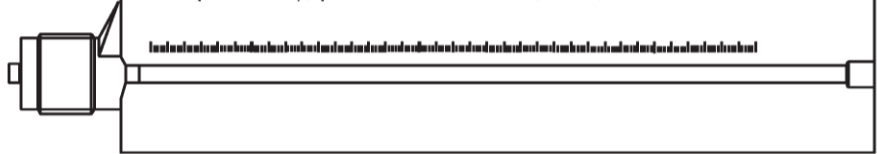
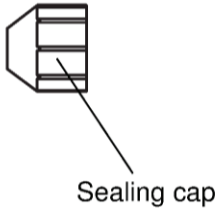

Coaxial cartridge, sizes: 300 ml, 380 ml, 400 ml, 410 ml

Marking: FIS VL, processing notes, shelf-life, hazard code, curing times and processing times (depending on temperature), piston travel scale, size, volume

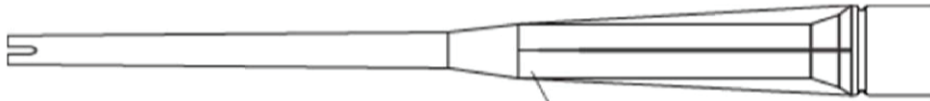
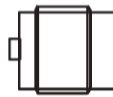

Static mixer FIS MR or static mixer FIS ME

**Reinforcing bar (rebar)  $\phi$  10,  $\phi$  12,  $\phi$  14,  $\phi$  16,  $\phi$  20,  $\phi$  25**

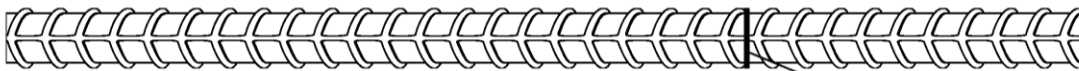

marking setting depth

**Rebar connection with fischer FIS VL**

**Product description**

Injection mortar; reinforcing bar

**Annex A 2**

**Figure A9: Properties of reinforcing bars (rebar)**

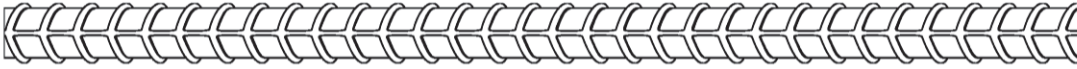

- The minimum value of related rip area  $f_{R,min}$  according to EN 1992-1-1:2004+AC:2010
- The maximum outer rebar diameter over the rips shall be:
  - The nominal diameter of the rip  $\phi + 2 * h$  ( $h \leq 0,07 * \phi$ )
  - ( $\phi$ : Nominal diameter of the bar;  $h$ : rip height of the bar)

**Table A1: Materials of rebars**

Designation	Reinforcing bar (rebar)
Reinforcing bar EN 1992-1-1:2004+AC:2010, Annex C	Bars and de-coiled rods class B or C with $f_{yk}$ and $k$ according to NDP or NCL of EN 1992-1-1/NA:2013 $f_{uk} = f_{tk} = k \cdot f_{yk}$

**Rebar connection with fischer FIS VL**

**Product description**  
Properties and materials of rebars

**Annex A 3**

**Specifications of intended use**

**Anchorage subject to:**

Static and quasi-static loads

**Base materials:**

- Reinforced or unreinforced normal weight concrete according to EN 206:2013  
Strength classes C20/25 to C35/45 according to EN 206:2013
- Maximum chloride concrete of 0,40% (CL 0.40) related to the cement content according to EN 206-1:2013
- Non-carbonated concrete

Note: In case of a carbonated surface of the existing concrete structure the carbonated layer shall be removed in the area of the post-installed rebar connection with a diameter of  $\phi + 60$  mm prior to the installation of the new rebar

The depth of concrete to be removed shall correspond to at least the minimum concrete cover in accordance with EN 1992-1-1:2004+AC:2010

The foregoing may be neglected if building components are new and not carbonated and if building components are in dry conditions

**Temperature Range:**

- -40°C to +80°C (max. short term temperature +80°C and max long term temperature +50°C)

**Design:**

- Anchorages are designed under the responsibility of an engineer experienced in anchorages and concrete work
- Verifiable calculation notes and drawings are prepared taking account of the forces to be transmitted
- Design according to EN 1992-1-1:2004+AC:2010 and Annex B 2 and Annex B3
- The actual position of the reinforcement in the existing structure shall be determined on the basis of the construction documentation and taken into account when designing

**Installation:**

- Dry or wet concrete
- It must not be installed in flooded holes
- Overhead installation allowed
- Hole drilling by hammerdrill or compressed airdrill mode
- The installation of post-installed rebar shall be done only by suitable trained installer and under Supervision on site; the conditions under which an installer may be considered as suitable trained and the conditions for Supervision on site are up to the Member States in which the installation is done
- Check the position of the existing rebars (if the position of existing rebars is not known, it shall be determined using a rebar detector suitable for this purpose as well as on the basis of the construction documentation and then marked on the building component for the overlap joint)

**Rebar connection with fischer FIS VL**

**Intended use**  
Specifications

**Annex B 1**

**Figure B1: General construction rules for post-installed rebars**

- Only tension forces in the axis of the rebar may be transmitted
- The transfer of shear forces between new concrete and existing structure shall be designed additionally according to EN 1992-1-1:2004+AC:2010
- The joints for concreting must be roughened to at least such an extent that aggregate protrude

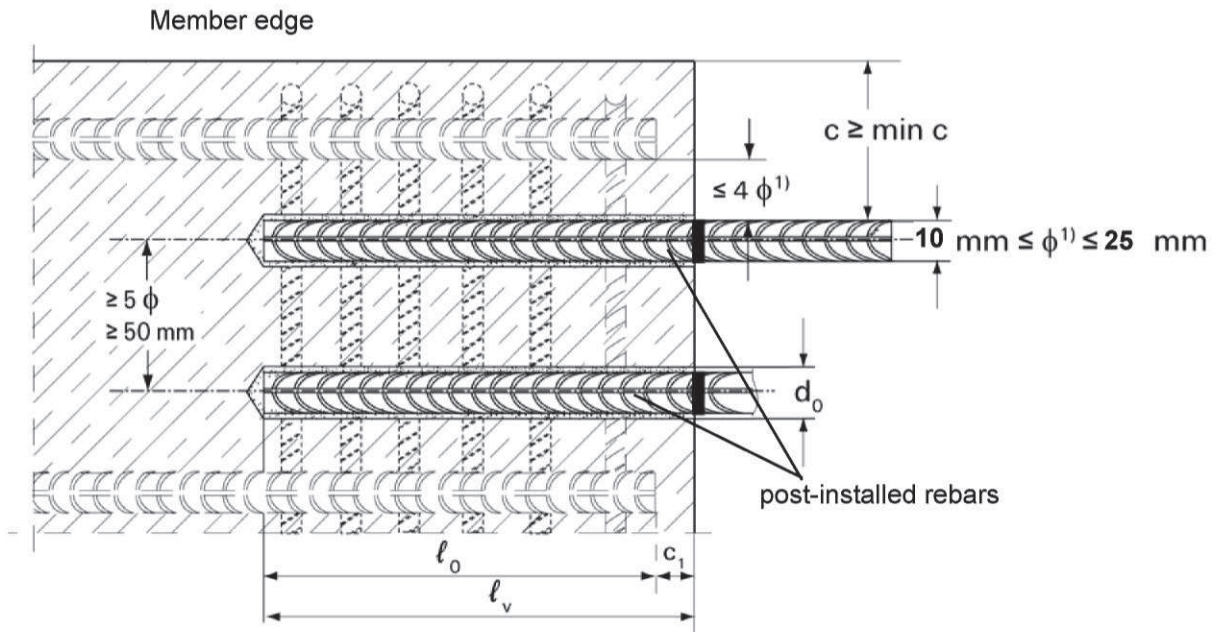

<sup>1)</sup> If the clear distance between lapped bars exceeds  $4 \phi$  then the lap length shall be increased by the difference between the clear bar distance and  $4 \phi$

- $c$  concrete cover of post-installed rebar
- $c_1$  concrete cover at end-face of existing rebar
- $\text{min } c$  minimum concrete cover according to Table B1 and to EN 1992-1-1:2004+AC:2010, Section 4.4.1.2
- $\phi$  nominal diameter of the bar
- $\ell_0$  lap length, according to EN 1992-1-1:2004+AC:2010, Section 8.7.3
- $\ell_v$  effective embedment depth,  $\geq \ell_0 + c_1$
- $d_0$  nominal drill bit diameter, see Annex B4

**Rebar connection with fischer FIS VL**

**Annex B 2**

**Intended use**

General construction rules for post-installed rebars



**Table B1:**  
Minimum concrete cover  $c^{1)}$  depending of the drilling method and the drilling tolerance

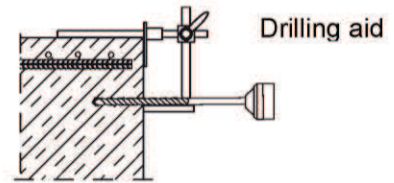

Drilling method	Nominal diameter of the bar $\phi$ [mm]	Minimum concrete cover min c	
		Without drilling aid [mm]	With drilling aid [mm]
Hammer drilling	$\leq 20$	30 mm + 0,06 $\ell_v$	30 mm + 0,02 $\ell_v \geq 2 \phi$
	$\geq 25$	40 mm + 0,06 $\ell_v$	40 mm + 0,02 $\ell_v \geq 2 \phi$
Compressed air drilling	$\leq 20$	50 mm + 0,08 $\ell_v$	50 mm + 0,02 $\ell_v$
	$\geq 25$	60 mm + 0,08 $\ell_v$	60 mm + 0,02 $\ell_v$

<sup>1)</sup> See Annex B2, Figure B1

Note: The minimum concrete cover as specified in EN 1992-1-1:2004+AC:2010 must be observed

**Table B2:**  
Dispensers and cartridge sizes corresponding to maximum embedment depth  $\ell_{v,max}$

Rebar	Manuel dispenser	Accu und pneumatic dispenser (small)	pneumatic dispenser (great)
	Cartridge size		
$\phi$ [mm]	< 500 ml;		>500 ml
	$\ell_{v,max} / \ell_{e,ges,max}$ [mm]		$\ell_{v,max} / \ell_{e,ges,max}$ [mm]
10	1000	1000	1800
12		1200	
14		1500	
16		1300	
20	700	1000	2000
25			

**Table B3: Working times  $t_{work}$  and curing times  $t_{cure}$**

Temperature in the anchorage base [°C]	Maximum working times <sup>1)</sup> $t_{work}$ [minutes]	Minimum curing times <sup>2)</sup> $t_{cure}$ [minutes]
> $\pm$ 0 to +5	13 <sup>3)</sup>	180
>+5 to +10	9 <sup>3)</sup>	90
>+10 to +20	5	60
>+20 to +30	4	45
>+30 to +40	2 <sup>4)</sup>	35

<sup>1)</sup> Maximum time from the beginning of the injection to rebar setting and positioning

<sup>2)</sup> For wet concrete the curing time must be doubled

<sup>3)</sup> If the temperature in the concrete falls below 0°C the cartridge has to be warmed up to +15°C.

<sup>4)</sup> If temperatures exceed 30 °C, cool the cartridge to +15°C...+20°C

Rebar connection with fischer FIS VL

**Intended use**

Minimum concrete cover/ Maximum embedment depth per dispenser and cartridge size/ Working times and curing times

**Annex B 3**

**Table B4:**  
**Installation tools for drilling and cleaning the bore hole and injection of the mortar**

Rebar $\phi$ [mm]	Drilling and cleaning						Injection			
	Nominal drill bit diameter $d_0$ [mm]		Diameter of cutting edge $d_{cut}$ [mm]		Steel brush diameter $d_b$ [mm]		Cleaning nozzle [mm]	Extension tube [mm]	Injection adapter [colour]	
10	12 <sup>1)</sup>	14 <sup>1)</sup>	$\leq 12,5$	$\leq 14,5$	12,5	15	11	9	white	blue
12	14 <sup>1)</sup>	16 <sup>1)</sup>	$\leq 14,5$	$\leq 16,5$	15	17	15		blue	red
14	18		$\leq 18,5$		19		19	9 or 15	yellow	
16	20		$\leq 20,55$		25				green	
20	25		$\leq 25,55$		26,5		black			
25	30		$\leq 30,55$		32		28		grey	

<sup>1)</sup>Both drill bit diameters can be use

**Rebar connection with fischer FIS VL**

**Intended use**

Installation tools for drilling and cleaning the bore hole and injection installation of the mortar

**Annex B 4**

**Safety regulations**



Review the Material Safety Data Sheet (MSDS) before use for proper and safe handling!

Wear well-fitting protective goggles and protective gloves when working with mortar fischer FIS VL

Important: Observe the instructions for use provided with each cartridge.

**1. Drill hole**

Note: Before drilling, remove carbonized concrete; clean contact areas (see Annex B 1)  
In case of aborted drill hole the drill hole shall be filled with mortar.

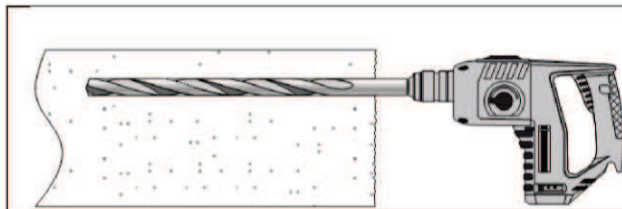

Drill hole to the required embedment depth using a hammer-drill with carbide drill bit set in rotation hammer mode or a compressed air drill.  
Drill bit sizes see Table B4.

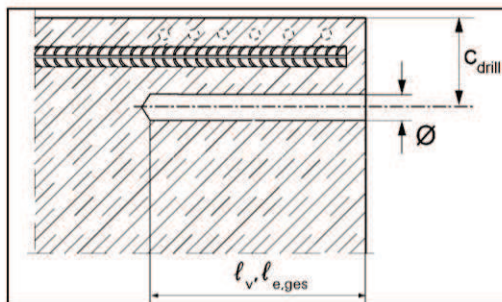

Measure and control concrete cover  $c$   
 $C_{drill} = c + \phi / 2$   
Drill parallel to surface edge and to existing rebar  
Where applicable use fischer drilling aid.

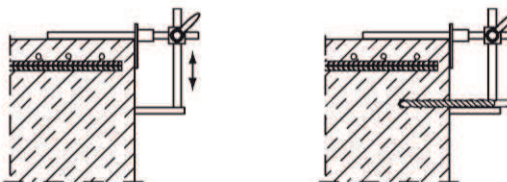

For holes  $l_v > 20$  cm use drilling aid.  
Three different options can be considered:

- A) fischer drilling aid
- B) Slat or spirit level
- C) Visual check

**Rebar connection with fischer FIS VL**

**Intended use**  
Installation instruction part 1

**Annex B 5**

**2.1 Compressed air cleaning**

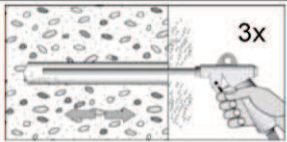
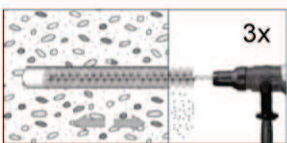
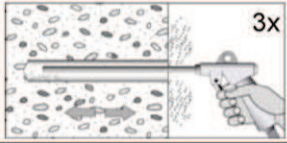

	<p><b>Blowing</b> three times from the back of the hole with oil-free compressed air (min. 6 bar) until return air stream is free of noticeable dust.</p>
	<p><b>Brushing (with power drill)</b> three times with the specified brush size (brush diameter &gt;: borehole diameter) by inserting the round steel brush to the back of the hole in a twisting motion. The brush shall produce natural resistance as it enters the anchor hole. If this is not the case, please use a new brush or a brush with a larger diameter. For appropriate brushes see Table B4.</p>
	<p><b>Blowing (control)</b> three times from the back of the hole with oil-free compressed air (min. 6 bar) until return air stream is free of noticeable dust.</p>

**Rebar connection with fischer FIS VL**

**Annex B 6**

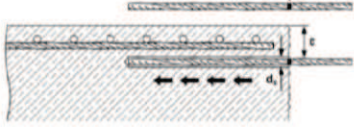
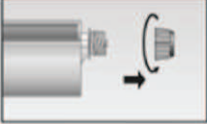
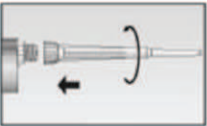

**Intended use**  
Installation instruction part 2

### 3. Rebar preparation and cartridge preparation

	<p>Before use, make asure that the rebar is dry and free of oil or other residue.                  Mark the embedment depth on the rebar (e.g. with tape) <math>l_v</math>                  Insert rebar in borehole, to verify hole and setting depth <math>l_v</math> resp. <math>l_{e,ges}</math></p>
<b>Injection system preparation</b>	
	<p>No. 1: Twist off the sealing cap</p>
	<p>No. 2: Twist on the static mixer (the spiral in the static mixer must be clearly visible).</p>
	<p>No. 3: Place the cartridge into a suitable dispenser.</p>
	<p>No. 4: Press out approximately 10 cm of mortar until the resin is permanently grey in colour. mortar which is not grey in colour will not cure and must be disposed of.</p>

### 4. Inject mortar into borehole

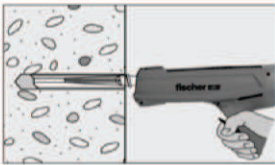
#### 4.1 borehole depth $\leq 250$ mm:



	<p>Inject the mortar from the back of the hole towards the front and slowly withdraw the mixing nozzle step by step after each trigger pull.                  Fill holes approximately 2/3 full, or as required to ensure that the annular gap between the rebar and the concrete is completely filled with adhesive over the embedment length.</p>
	<p>After injecting, depressurize the dispenser by pressing the release trigger. This will prevent further mortar discharge from the mixing nozzle.</p>

Rebar connection with fischer FIS VL

Annex B 7

**Intended use**  
 Installation instruction part 3

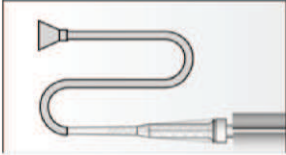
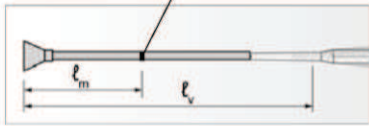
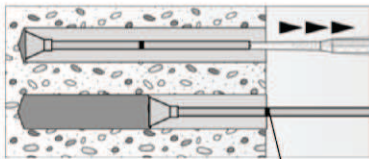
4.2 borehole depth > 250 mm:



	<p>Assemble mixing nozzle, extension tube and injection adapter (see Table B 4)</p>
 <p>Mortar level mark</p>	<p>Mark the required mortar level <math>l_m</math> and embedment depth <math>l_v</math> resp. <math>l_{e,ges}</math> with tape or marker on the injection extension tube.</p> <p>a) Estimation:</p> $l_m = \frac{1}{3} * l_v \text{ resp. } l_m = \frac{1}{3} * l_{e,ges}$ <p>b) Precise formula for optimum mortar volume:</p> $l_m = l_v \text{ resp. } l_{e,ges} \left( (1,2 * \frac{d_s^2}{d_0^2} - 0,2) \right) [\text{mm}]$
 <p>Mortar level mark</p>	<p>Insert injection adapter to back of the hole. Begin injection allowing the pressure of the injected adhesive mortar to push the injection adapter towards the front of the hole.</p> <p>Fill holes approximately 2/3 full, or as required to ensure that the annular gap between the rebar and the concrete is completely filled with adhesive over the embedment length.</p> <p>When using an injection adapter continue injection until the mortar level mark <math>l_m</math> becomes visible.</p> <p>Maximum embedment depth see Table B 2</p>
	<p>After injecting, depressurize the dispenser by pressing the release trigger. This will prevent further mortar discharge from the mixing nozzle.</p>

Rebar connection with fischer FIS VL

Annex B 8

Intended use  
Installation instruction part 4

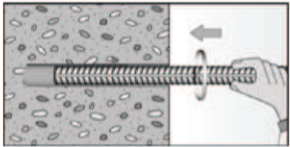
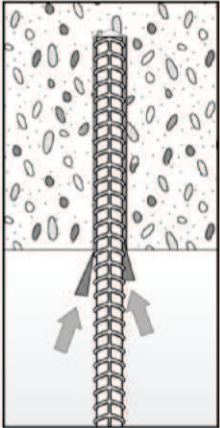
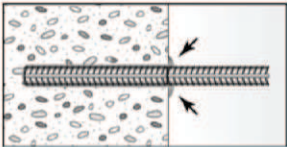
### 4.3 Insert rebar

	<p>For each installation insert the rebar slowly twisted into the borehole until the embedment mark is at the concrete surface level.</p>
	<p>Support the rebar and secure it from falling till mortar started to harden, e.g. using wedges.</p>
	<p>After installing the rebar the annular gap must be completely filled with mortar.</p> <p>Proper installation</p> <ul style="list-style-type: none"> <li>• Desired anchoring embedment is reached <math>l_v</math>: embedment mark at concrete surface.</li> <li>• Excess mortar flows out of the borehole after the rebar has been fully inserted until the embedment mark.</li> </ul>
	<p>Observe the working time "<math>t_{work}</math>" (see Table B3), which varies according to temperature of base material. Minor adjustments to the rebar position may be performed during the working time</p> <hr/> <p>Full load may be applied only after the curing time "<math>t_{cure}</math>" has elapsed (see Table B 3)</p>

Rebar connection with fischer FIS VL

Annex B 9

**Intended use**  
Installation instruction part 5

### Minimum anchorage length and minimum lap length

The minimum anchorage length  $\ell_{b,min}$  and the minimum lap length  $\ell_{o,min}$  according to EN 1992-1-1:2004+AC:2010 ( $\ell_{b,min}$  acc. to Eq. 8.6 and Eq. 8.7 and  $\ell_{o,min}$  acc. to Eq. 8.11) shall be multiply by a factor according to Table C1.

**Table C1: Factor related to concrete class and drilling method**

Concrete class	Drilling method	Factor
C20/25 to C35/45	Hammer drilling and compressed air drilling	1,0

**Table C2: Design values of the ultimate bond resistance  $f_{bd}$  in N/mm<sup>2</sup> for hammer drilling and compressed air drilling**

According to EN 1992-1-1: 2004+AC:2010 for good bonds conditions (for all other bond conditions multiply the values by 0,7)

Rebar	Bond resistance $f_{bd}$ [N/mm <sup>2</sup> ]			
	Concrete class			
	C20/25	C25/30	C30/37	C35/45
$\phi$ [mm] 10 to 25	2,3	2,7	3,0	3,4

Rebar connection with fischer FIS VL

Annex C 1

**Performances**

Minimum anchorage length and minimum lap length  
Design values of ultimate bond resistance  $f_{bd}$