



LEISTUNGSERKLÄRUNG



DoP: 0147

für fischer Betonschraube ULTRACUT FBS II (Metallanker zur Verwendung in Beton zur Befestigung von leichten Systemen)
– DE

1. Eindeutiger Kenncode des Produkttyps: **DoP: 0147**
2. Verwendungszweck(e): **Für Mehrfachbefestigungen von nichttragenden Systemen in gerissenem und ungerissenem Beton. zur Verwendung in redundanten Systemen zur Befestigung und/oder Verankerung von Bauteilen z.B. leichten abgehängten Decken, sowie von Installationen am bzw. im Beton, siehe Anhang, insbesondere Anhänge B 1 bis B 5**
3. Hersteller: **fischerwerke GmbH & Co. KG, Klaus-Fischer-Straße 1, 72178 Waldachtal, Deutschland**
4. Bevollmächtigter: --
5. System(e) zur Bewertung und Überprüfung der Leistungsbeständigkeit: **2+**
6. Europäisches Bewertungsdokument: **EAD 330747-00-0601**
Europäische Technische Bewertung: **ETA-18/0242; 2018-10-30**
Technische Bewertungsstelle: **DIBt**
Notifizierte Stelle(n): **1343 – MPA Darmstadt**

7. Erklärte Leistung(en):

Brandschutz (BWR 2)

- **Brandverhalten: Der Dübel erfüllt die Anforderungen der Klasse A 1**
- **Feuerwiderstand: Siehe Anhang, insbesondere Anhang C 3**

Sicherheit bei der Nutzung (BWR 4)

- **Charakteristische Zugtragfähigkeit (statische und quasi-statische Einwirkungen):
Siehe Anhang, insbesondere Anhänge C 1 – C 2**
- **Charakteristische Quertragfähigkeit (statische und quasi-statische Einwirkungen):
Siehe Anhang, insbesondere Anhänge C 1 – C 2**

8. Angemessene Technische Dokumentation und/oder Spezifische Technische Dokumentation: ---

Die Leistung des vorstehenden Produkts entspricht der erklärten Leistung/den erklärten Leistungen. Für die Erstellung der Leistungserklärung im Einklang mit der Verordnung (EU) Nr. 305/2011 ist allein der obengenannte Hersteller verantwortlich.

Unterzeichnet für den Hersteller und im Namen des Herstellers von:

Andreas Bucher, Dipl.-Ing.

Wolfgang Hengesbach, Dipl.-Ing., Dipl.-Wirtsch.-Ing.

Tumlingen, 2018-11-06

- Diese Leistungserklärung wurde in verschiedenen Sprachversionen erstellt. Für den Fall unterschiedlicher Auslegung hat immer die englische Version Vorrang.
- Der Anhang enthält freiwillige und ergänzende Informationen in englischer Sprache. Diese gehen über die (sprachneutral angebenen) gesetzlichen Anforderungen hinaus.

Specific Part

1 Technical description of the product

The fischer concrete screw ULTRACUT FBS II is an anchor of size 6 mm made of hardened carbon steel. The anchor is screwed into a predrilled cylindrical drill hole. The special thread of the anchor cuts an internal thread into the member while setting. The anchorage is characterised by mechanical interlock in the special thread.

The product description is given in Annex A.

2 Specification of the intended use in accordance with the applicable EAD

The performances given in Section 3 are only valid if the anchor is used in compliance with the specifications and conditions given in Annex B.

The verifications and assessment methods on which this European Technical Assessment is based lead to the assumption of a working life of the anchor of at least 50 years. The indications given on the working life cannot be interpreted as a guarantee given by the producer, but are to be regarded only as a means for choosing the right products in relation to the expected economically reasonable working life of the works.

3 Performance of the product and references to the methods used for its assessment

3.1 Safety in case of fire (BWR 2)

Essential characteristic	Performance
Reaction to fire	Class A1
Resistance to fire	See Annex C 3

3.2 Safety in use (BWR 4)

Essential characteristic	Performance
Characteristic resistance to tension load (static and quasi-static loading)	See Annex C 1 and C 2
Characteristic resistance to shear load (static and quasi-static loading)	See Annex C 1 and C 2

4 Assessment and verification of constancy of performance (AVCP) system applied, with reference to its legal base

In accordance with European Assessment Document EAD No. 330747-00-0601, the applicable European legal act is: [97/161/EC].

The system to be applied is: 2+

Product in the installed condition

Installed condition in normal weight concrete

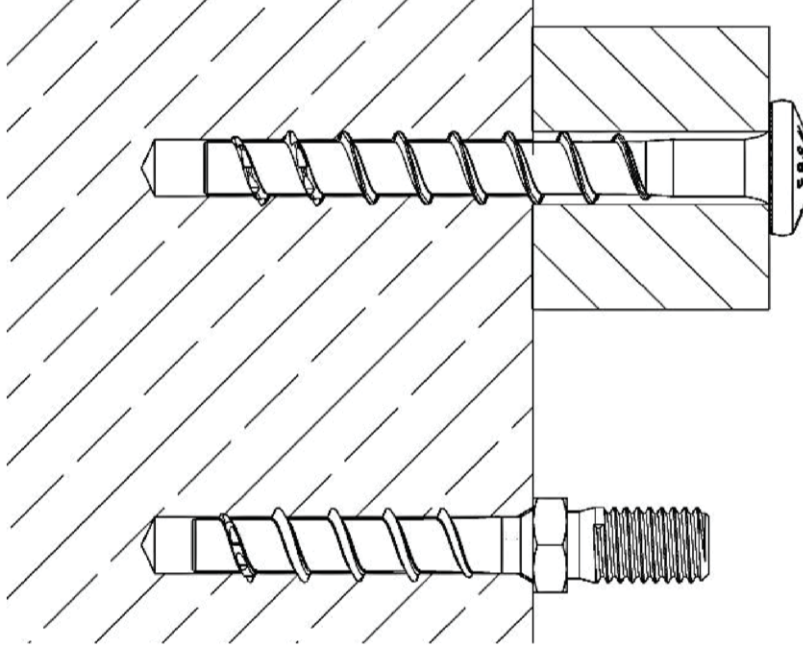

Installed condition in prestressed hollow core slabs

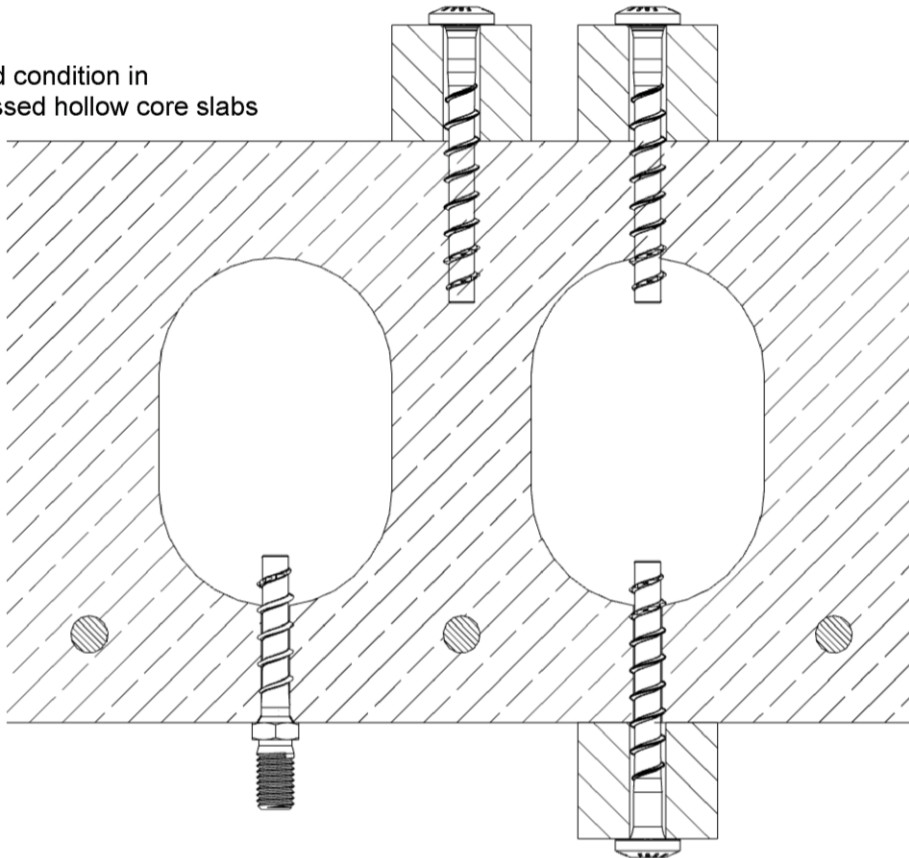





fischer concrete screw ULTRACUT FBS II

Product description
Product in the installed condition

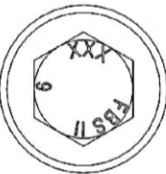
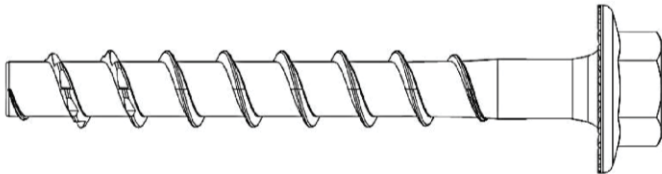
Annex A 1

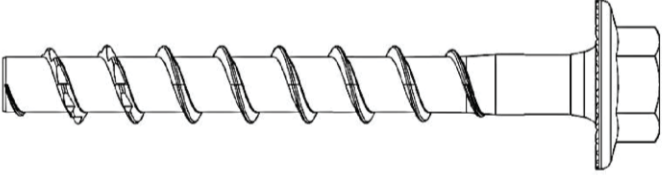
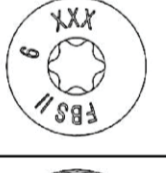
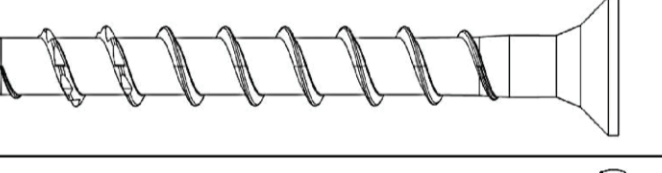
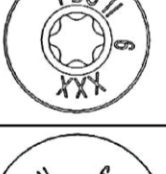
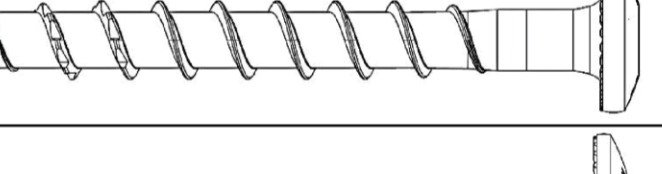
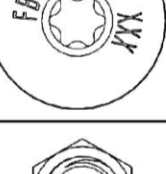
Table A2.1: Screw types

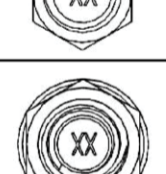
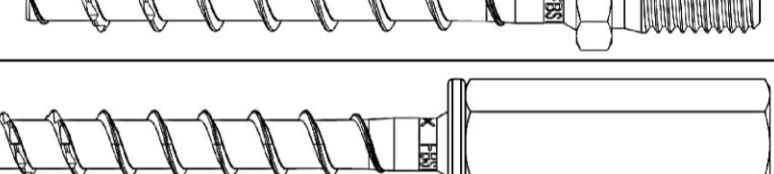
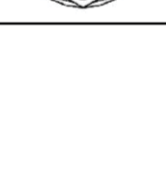
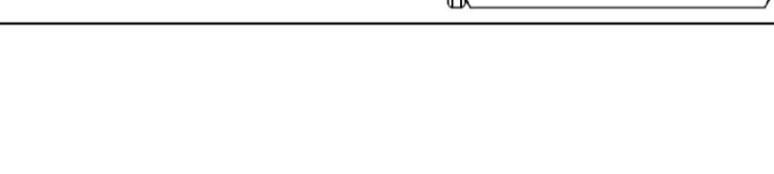
FBS II 6		
Hexagon head with formed washer (US)		
Hexagon head with formed washer and TX-drive (US TX)		
Countersunk head (SK)		
Pan head (P)		
Large pan head (LP)		
Hexagon head and connection thread M8 or M10 (M)		
Internal thread M8 / M10 combined (M8 / M10 I)		

fischer concrete screw ULTRACUT FBS II

Product description
Screw types

Annex A 2

Table A3.1: Geometry and material		
FBS II 6		All head shapes
Thread outer diameter	d_a	[mm]
Core diameter	d_k	
Shaft diameter	d_s	
Material	[-]	Hardened carbon steel; $A_{5\%} \geq 8\%$
Coating		galvanized

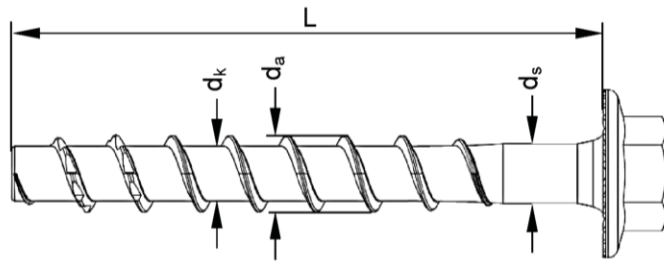

Head marking at US, US TX, SK, P, LP

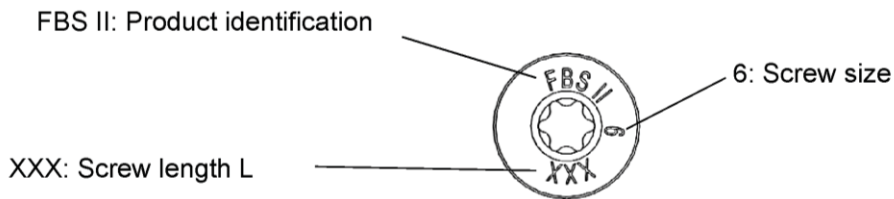

Marking at M8, M10, M8 / M10 I

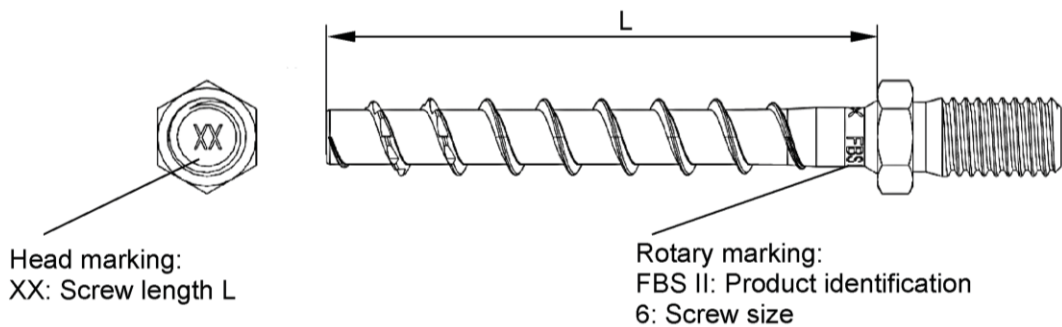

fischer concrete screw ULTRACUT FBS II	Annex A 3
Product description Geometry and marking	

Specification of intended use:

Anchorage subject to:

- Static and quasi static loads: all types and embedment depths
- Used in concrete for redundant non-structural systems
- Used for fire: only for concrete C20/25 to C50/60 (does not apply for prestressed hollow core slabs)

Base materials:

- Compacted reinforced or unreinforced normal weight concrete without fibres according to EN 206:2013
- Strength classes C20/25 to C50/60 according to EN 206:2013
- Uncracked or cracked concrete
- Prestressed hollow core slabs, where the cavity width does not exceed 4.2 times the web width ($b_H \leq 4,2 \times b_{St}$) with strength classes C30/37 to C50/60

Use conditions (Environmental conditions):

- Structures subjected to dry internal conditions

Design:

- Anchorages are to be designed under the responsibility of an engineer experienced in anchorages and concrete work
- Verifiable calculation notes and drawings are to be prepared taking account of the loads to be anchored. The position of the screw is indicated on the design drawings (e.g. position of the screw relative to reinforcement or to supports, etc.)
- Design of fastenings according to FprEN 1992-4: 2016 and EOTA Technical Report TR 055

Installation:

- Hammer drilling or hollow drilling
- Screw installation carried out by appropriately qualified personnel and under the supervision of the person responsible for technical matters on site
- In case of aborted hole: New hole must be drilled at a minimum distance of twice the depth of the aborted hole or closer, if the hole is filled with a high strength mortar and only if the hole is not in the direction of the oblique tensile or shear load
- Adjustability according to Annex B3
- Cleaning of drill hole is not necessary when using a hollow drill or:
 - If drilling vertically upwards
 - If drilling vertically downwards and the drill hole depth has been increased. It is recommended to increase the drill depth with additional $3 d_0$
- After correct installation further turning of the screw head shall not be possible
- The head of the screw must be fully engaged on the fixture and show no signs of damage
- In prestressed hollow core slabs the screw may be installed from all directions, if the web thickness and the spacing to the tensioning strands according to table B3.1 are observed (also in the area of solid material)

fischer concrete screw ULTRACUT FBS II

Intended use
Specification

Annex B 1

Table B2.1: Installation parameters – drilling bore hole and setting tools			
FBS II 6		All head shapes	
Nominal embedment depth	h_{nom}	$25 \leq h_{nom} < 35$	$35 \leq h_{nom} \leq 55$
Nominal drill hole diameter	d_0	6	
Cutting diameter of drill bits	$d_{cut} \leq$	6,4	
Clearance hole diameter	$d_f \leq$	8	
Drill hole depth		$h_{nom} + 5$	$h_{nom} + 10^{1)}$
Drill hole depth (with adjustable setting)	$h_1 \geq$	$h_{nom} + 15$	$h_{nom} + 20$
Torque impact screw driver	$T_{imp,max}$	80	450
Maximum installation torque with hexagon nut on head shapes M8, M10 and M8/M10 I	T_{max}	5	10

¹⁾ Value can be reduced to $h_{nom} + 5$ for installation vertically upwards

Table B2.2: Installation parameters – drive and fixture			US	US TX	SK	P	LP	M8	M10	M8/M10 I
Wrench size	SW	[mm]	10	-				10	13	
TX size	TX	[-]	-	30				-		
Head diameter	d_h		17	13,5	14,4	17,5				
Thickness of fixture	$t_{fix} \leq$	[mm]	$L - h_{nom}$				25			
Length of screw	$L_{min} =$		325							
	$L_{max} =$									

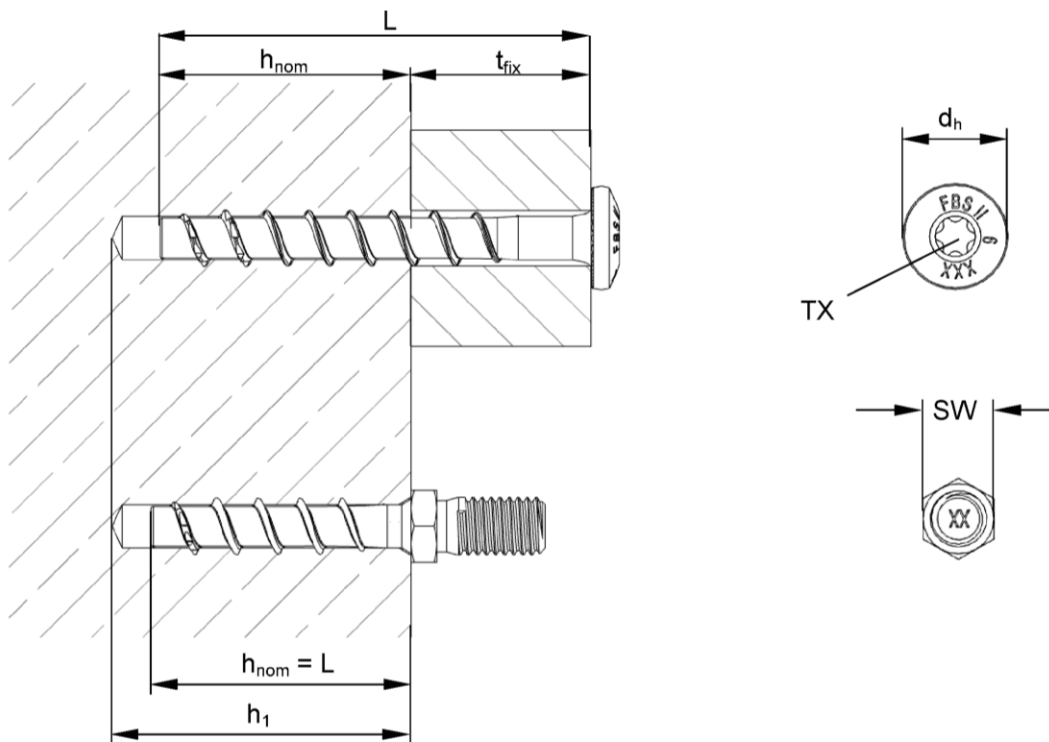

fischer concrete screw ULTRACUT FBS II

Intended use
Installation parameters

Annex B 2

Table B3.1: Installation parameters – Additional information for prestressed hollow core slabs

FBS II 6			
Distance to the tensioning strands	$a_p \geq$		50
Thickness of the slab web	$d_b \geq$	[mm]	25
Minimum thickness of fixture	$t_{fix} \geq$		$L - d_b^{1)}$ - 30 mm
Torque impact screw driver	$T_{imp,max}$	[Nm]	80 (450 ²⁾)

- 1) If d_b is not known, then set $d_b = 25$ mm
 2) Parent value applies if all the following conditions are met:
 - $d_b \geq 35$ mm
 - $h_{nom} \geq 35$ mm

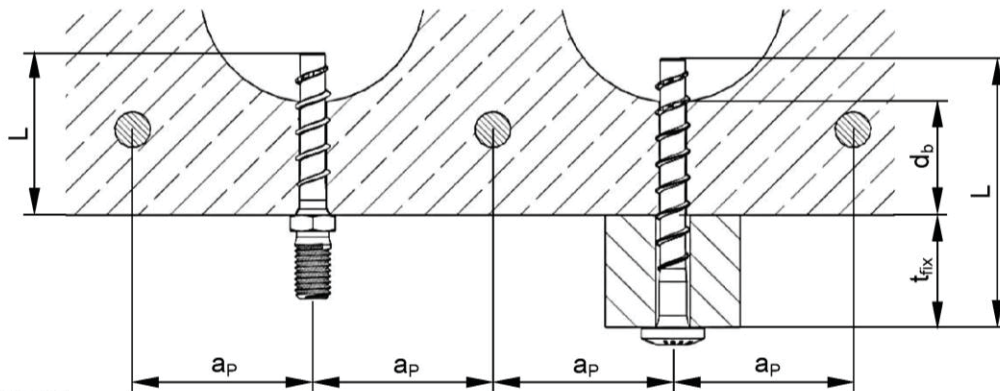

Adjustment

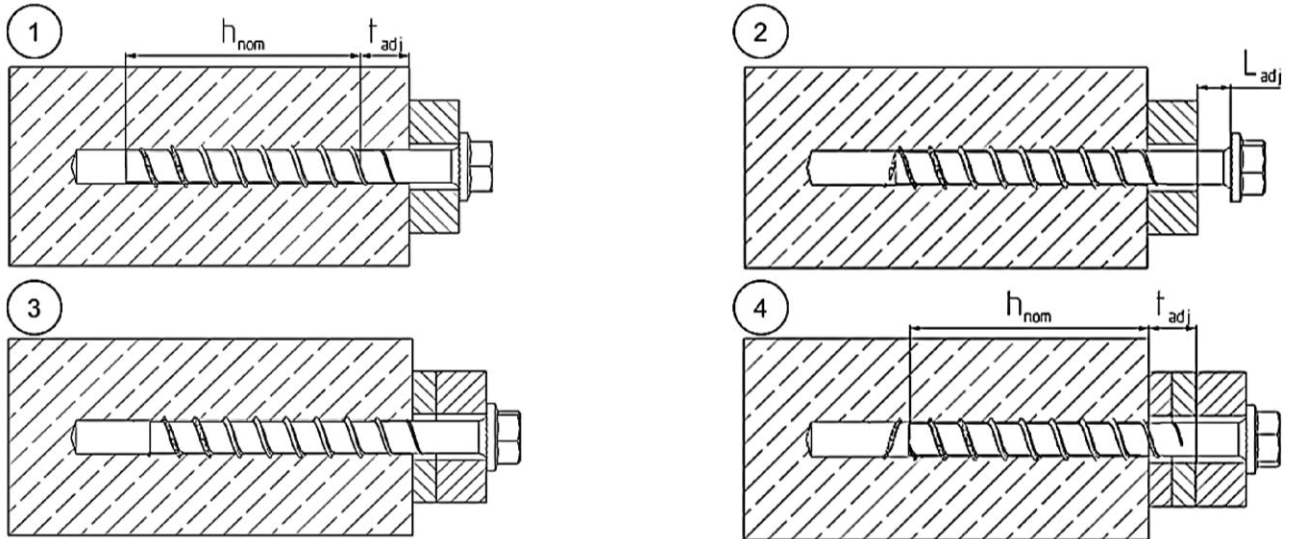

It is permissible to untighten the screw up to two times for adjustment purposes. Therefore the screw may be untightened to a maximum of $L_{adj} = 20$ mm to the surface of the initial fixture. The total permissible thickness of shims added during the adjustment process is $t_{adj} = 10$ mm.

fischer concrete screw ULTRACUT FBS II

Intended use
 Prestressed hollow core slabs and adjustment

Annex B 3

Table B4.1: Minimum thickness of concrete members, minimum spacing and edge distance			
FBS II 6			
Minimum thickness of concrete member	h_{min}		$\max.(80; h_1^{1}) + 30)$
Minimum spacing	s_{min}		35
Minimum edge distance	c_{min}		
1) Drill hole depth according to table B2.1			
Table B4.2: Minimum spacing and edge distance for prestressed hollow core slabs			
FBS II 6			
Minimum spacing	s_{min}	[mm]	100
Minimum edge distance	c_{min}		
Minimum distance between anchor groups	a_{min}		
fischer concrete screw ULTRACUT FBS II			Annex B 4
Intended use Minimum thickness of members, minimum spacing and edge distance			

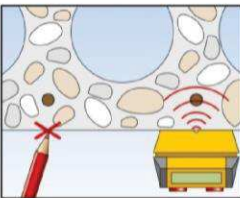
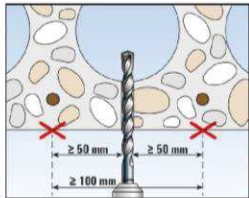
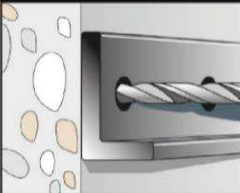
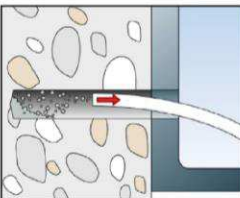
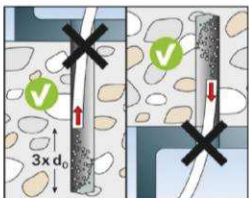
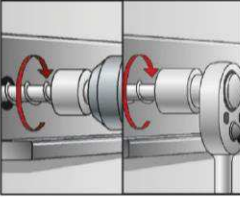
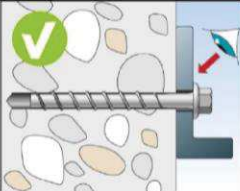
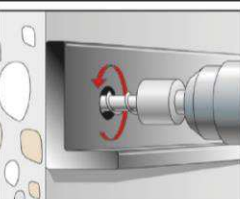
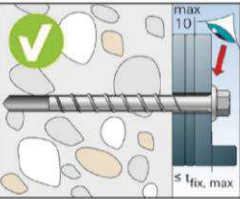
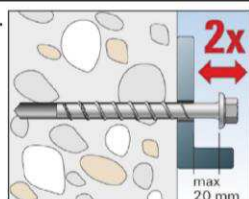
Installation instruction		
Installation of fischer concrete screw ULTRACUT FBS II 6		
1. 	2. 	For installation in prestressed hollow core slabs: Determine and mark the position of the tensioning strands, e.g. with a suitable scanner. Keep distances to the tensioning strands according to table B3.1.
		Drill the hole using hammer drill or hollow drill. Drill hole diameter d_0 and drill hole depth h_1 according to table B2.1
a) 	b) 	Option a): Clean the drill hole Option b): Cleaning of drill hole is not necessary when using a hollow drill or: - If drilling vertically upwards or - If drilling vertically downwards and the drill hole depth has been increased. It is recommended to increase the drill hole depth additional 3 times d_0 .
		Installation with any torque impact screw driver up to the maximum mentioned torque moment ($T_{imp,max}$ according table B2.1). Alternatively, all other tools without an indicated torque moment are allowed (e.g. ratchet spanner). The indicated torque moments for impact screw driver are therefore not decisive.
		After installation a further turning of the screw must not be possible. The head of the screw must be in contact with the fixture and is not damaged.
1.  3. 	2. 	OPTIONAL: It is permissible to adjust the screw twice. Therefore the screw may be untightened to a maximum of $L_{adj} = 20$ mm off the surface of the initial fixture. The total permissible thickness of shims added during the adjustment process is $t_{adj} = 10$ mm.
fischer concrete screw ULTRACUT FBS II		
Intended use Installation instruction		Annex B 5

Table C1.1: Characteristic values for static and quasi-static action										
FBS II 6										
Nominal embedment depth	h_{nom}	[mm]	25	30	35	40	45	50	55	
Steel failure for tension load and shear load										
Characteristic resistance	$N_{Rk,s}$	[kN]	21							
Partial factor	γ_{Ms}	[-]	1,4							
Characteristic resistance	$V_{Rk,s}$	[kN]	4,8		9,0				13,3	
Partial factor	γ_{Ms}	[-]	1,5							
Factor for ductility	k_7	[-]	1,0							
Characteristic bending resistance	$M^0_{Rk,s}$	[Nm]	17,1							
Pullout failure										
Characteristic resistance in concrete C20/25	uncracked	$N_{Rk,p}$	[kN]	3,0	5,0	6,5	8,0	10,0	12,0	13,5
	cracked		[kN]	1,5	2,5	3,5	5,0	6,0	7,5	8,5
Increasing factors concrete	C25/30	ψ_c	[-]	1,12						
	C30/37			1,22						
	C35/45			1,32						
	C40/50			1,41						
	C45/55			1,50						
C50/60	1,58									
Installation factor	γ_{inst}			1,0						
Concrete cone failure and splitting failure; concrete pryout failure										
Effective embedment depth	h_{ef}	[mm]	19	23	27	32	36	40	44	
Factor for uncracked concrete	$k_{ucr,N}$	[-]	11,0							
Factor for cracked concrete	$k_{cr,N}$		7,7							
Characteristic edge distance	$c_{cr,N}$	[mm]	1,5 h_{ef}							
Characteristic spacing	$s_{cr,N}$		3 h_{ef}							
Charakt. resistance for splitting	$N^0_{Rk,sp}$	[kN]	$N_{Rk,c}$							
Charact. edge distance for splitting	$c_{cr,sp}$	[mm]	2 x h_{ef}			1,5 x h_{ef}				
Charakt. spacing for splitting	$s_{cr,sp}$		4 x h_{ef}			3 x h_{ef}				
Factor for pryout failure	k_8	[-]	1,3		2,0					
Installation factor	γ_{inst}		1,0							
Concrete edge failure										
Effective length in concrete	l_f	[mm]	25	30	35	40	45	50	55	
Nominal diameter of screw	d_{nom}		6							
Adjustment										
Maximum thickness of shims	t_{adj}	[mm]	10							
Max. number of adjustments	n_a	[-]	2							
fischer concrete screw ULTRACUT FBS II								Annex C 1		
Performances Characteristic values										

Table C2.1: Characteristic values for static and quasi-static action in prestressed hollow core slabs										
FBS II 6										
Nominal embedment depth	h_{nom}	[mm]	25	30	35	40	45	50	55	
Steel failure for tension load and shear load										
Characteristic resistance	$N_{Rk,s}$	[kN]	21							
Partial factor	γ_{Ms}	[-]	1,4							
Characteristic resistance	$V_{Rk,s}$	[kN]	4,8	9,0					13,3	
Partial factor	γ_{Ms}	[-]	1,5							
Factor for ductility	k_7	[-]	1,0							
Characteristic bending resistance	$M^0_{Rk,s}$	[Nm]	17,1							
Pullout failure, Concrete cone failure, Concrete edge failure, Concrete pryout failure for all load directions										
Characteristic resistance in C30/37 for thickness of the slab web	$d_b \geq 25$ mm	$F_{Rk,p}$	[kN]	0,5	1,0					
	$d_b \geq 30$ mm			3,5						
	$d_b \geq 35$ mm			3,5	4,0	4,5	5,0	5,5	6,0	6,5
	$d_b \geq 40$ mm				5,0	5,5	6,0	7,0	7,5	8,0
	$d_b \geq 50$ mm				5,5	7,0	8,0	9,5	11,0	12,0
Increasing factor concrete	C35/45	ψ_c	[-]	1,08						
	C40/50			1,15						
	C45/55			1,22						
	C50/60			1,29						
Installation factor	γ_{inst}	[-]	1,0							
fischer concrete screw ULTRACUT FBS II									Annex C 2	
Performances Characteristic values in prestressed hollow core slabs										

Table C3.1: Characteristic values for resistance to fire ¹⁾									
FBS II 6									
Nominal embedment depth	h_{nom}	[mm]	25	30	35	40	45	50	55
Steel failure for tension load and shear load ($F_{Rk,s,fi} = N_{Rk,s,fi} = V_{Rk,s,fi}$)									
Characteristic resistance for all head shapes	$F_{Rk,s,fi}$	R30	[kN]	1,00					
		R60		0,60					
		R90		0,50					
		R120		0,40					
Characteristic bending resistance for all head shapes	$M^0_{Rk,s,fi}$	R30	[Nm]	0,80					
		R60		0,50					
		R90		0,40					
		R120		0,35					
Edge distance									
R30 to R120	$c_{cr,fi}$	[mm]	2 h_{ef}						
In case of fire attack from more than one side, the minimum edge distance shall be ≥ 300 mm									
Spacing									
R30 to R120	$s_{cr,fi}$	[mm]	2 $c_{cr,fi}$						
¹⁾ The embedment depth has to be increased for wet concrete by at least 30 mm compared to the given value.									
fischer concrete screw ULTRACUT FBS II								Annex C 3	
Performances Characteristic values for resistance to fire									